

Latches, the D Flip-Flop & Counter Design

ECE 152A – Winter 2012

Reading Assignment

- Brown and Vranesic
 - 7 Flip-Flops, Registers, Counters and a Simple Processor
 - 7.1 Basic Latch
 - 7.2 Gated SR Latch
 - 7.2.1 Gated SR Latch with NAND Gates
 - 7.3 Gated D Latch
 - 7.3.1 Effects of Propagation Delays

Reading Assignment

- Brown and Vranesic (cont)
 - 7 Flip-Flops, Registers, Counters and a Simple Processor (cont)
 - 7.4 Master-Slave and Edge-Triggered D Flip-Flops
 - 7.4.1 Master-Slave D Flip-Flop
 - 7.4.2 Edge-Triggered D Flip-Flop
 - 7.4.3 D Flip-Flop with Clear and Preset
 - 7.4.4 Flip-Flop Timing Parameters (2nd edition)

Reading Assignment

- Roth
 - 11 Latches and Flip-Flops
 - 11.1 Introduction
 - 11.2 Set-Reset Latch
 - 11.3 Gated D Latch
 - 11.4 Edge-Triggered D Flip-Flop

Reading Assignment

- **Roth (cont)**
 - 12 Registers and Counters
 - 12.1 Registers and Register Transfers
 - 12.2 Shift Registers
 - 12.3 Design of Binary Counters
 - 12.4 Counters for Other Sequences

Combinational vs. Sequential Logic

- **Combinational logic**
 - Function of present inputs only
 - Output is known if inputs (some or all) are known
- **Sequential logic**
 - Function of past and present inputs
 - Memory or “state”
 - Output known if present input and present state are known
 - Initial conditions often unknown (or undefined)

Gate Delays

- Recall from earlier lecture
 - When gate inputs change, outputs don't change instantaneously

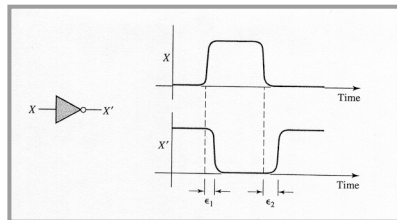

February 6, 2012

ECE 152A - Digital Design Principles

7

Feedback

- Outputs connected to inputs
 - Single inverter feedback
 - If propagation delay is long enough, output will oscillate

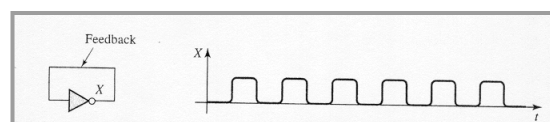

February 6, 2012

ECE 152A - Digital Design Principles

8

Feedback

- If the propagation delay is not long enough, the output will settle somewhere in the middle
 - $V_{in} = V_{out}$

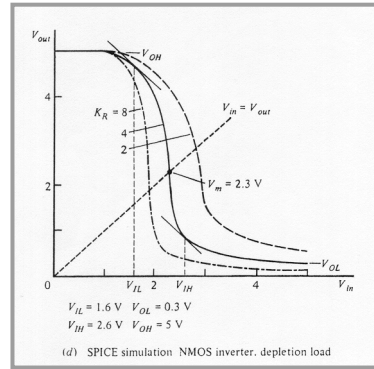

Feedback

- Ring Oscillator
 - Any odd number of inverters will oscillate
 - $\frac{1}{2}$ period = total prop delay of chain

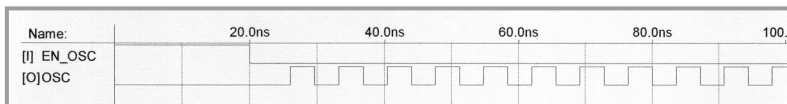
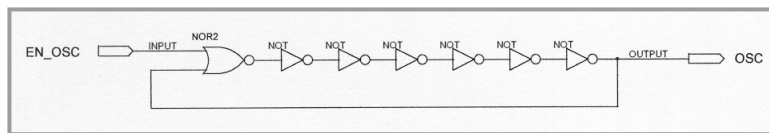

Feedback

- What about an even number of inversions?
 - Two inverter feedback
 - Memory (or State)
 - Static 1 or 0 “stored” in memory

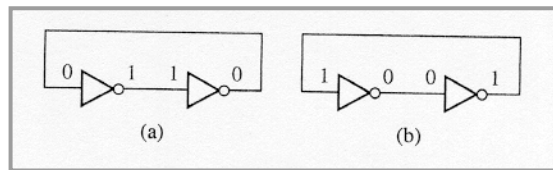

The Latch

- Replace inverters with NOR gates

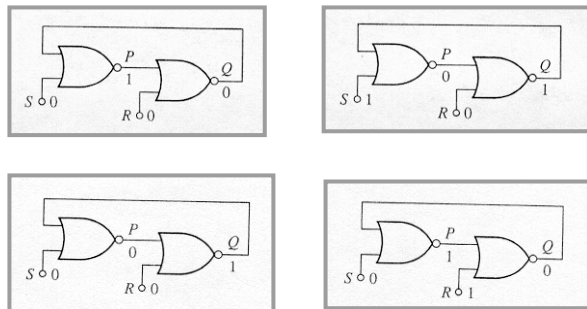

The Set-Reset (SR) Latch

- NOR implementation
 - Inverted feedback

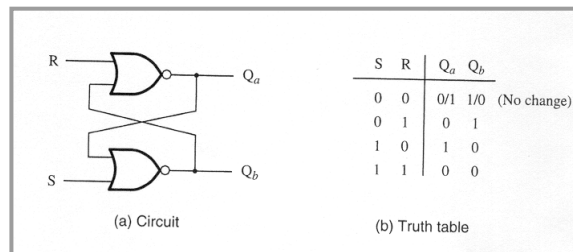

The SR Latch

- R = Reset (clear)
 - $Q \rightarrow 0, Q^* \rightarrow 1$
- S = Set (preset)
 - $Q \rightarrow 1, Q^* \rightarrow 0$
- NOR gate implementation
 - Either input = 1 forces an output to 0

The SR Latch (cont)

■ Terminology

- Present state, Q
 - Current value of Q and Q*
- Next state, Q⁺
 - Final value of Q and Q* after input changes

The SR Latch (cont)

■ Operation

- S=1, R=0 : set to 1, Q⁺ = 1
- S=0, R=1 : reset to 0, Q⁺ = 0
- S=0, R=0 : hold state, Q⁺ = Q
- S=1, R=1 : not allowed
 - Q⁺ = Q^{**} = 0, lose state

The SR Latch (cont)

■ Timing Diagram

- RS inputs are “pulses”
 - Temporarily high, but normally low

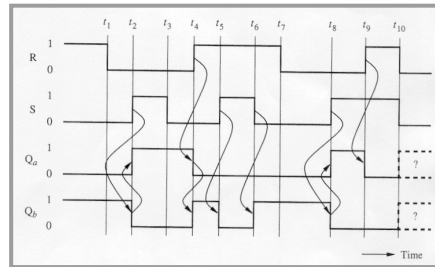

February 6, 2012

ECE 152A - Digital Design Principles

17

The SR Latch (cont)

■ Characteristic Equation

- Algebraic expression of flip-flop behavior
- Plot characteristic table on map, find Q^+
 - $Q^+ = S + R'Q$ ($S = R = 1$ not allowed)

S(t)	R(t)	Q(t)	Q(t + Δ)
0	0	0	0
0	0	1	1
0	1	0	0
0	1	1	0
1	0	0	1
1	0	1	1
1	1	0	—
1	1	1	—

] inputs not allowed

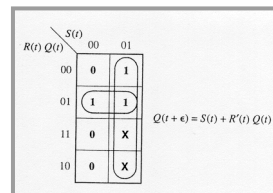

February 6, 2012

ECE 152A - Digital Design Principles

18

The SR Latch (cont)

■ Characteristic Equation

- $Q^+ = S + R'Q$ ($S = R = 1$ not allowed)
 - Q becomes 1 when $S = 1, R = 0$
 - Stays Q when $S = R = 0$
 - Q becomes 0 when $S = 0, R = 1$

The SR Latch (cont)

■ State Table

PS (Q)	NS (Q ⁺)			
	SR=00	01	10	11
0	0	0	1	X
1	1	0	1	X

The SR Latch (cont)

■ State Diagram

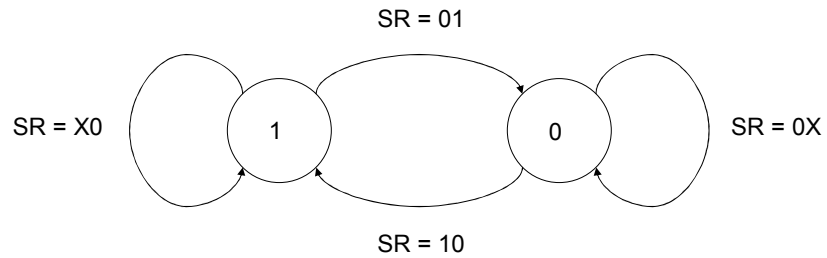

February 6, 2012

ECE 152A - Digital Design Principles

21

The SR Latch with NANDS

■ NAND Based S'R' Latch

- $S' = R' = 0$ not allowed
- Either input = 0 forces output to 1

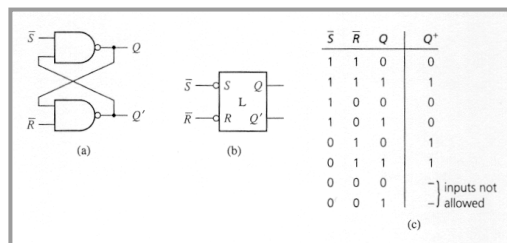

February 6, 2012

ECE 152A - Digital Design Principles

22

The Gated SR Latch

- Also known as “transparent” latch
 - Output follows input (transparent) when enabled

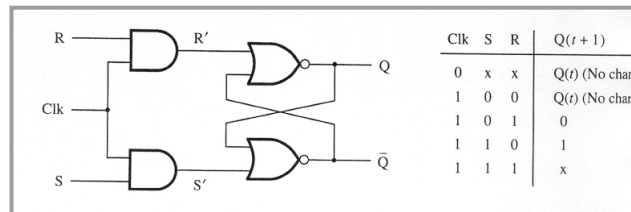

February 6, 2012

ECE 152A - Digital Design Principles

23

The Gated SR Latch (cont)

- Timing Diagram

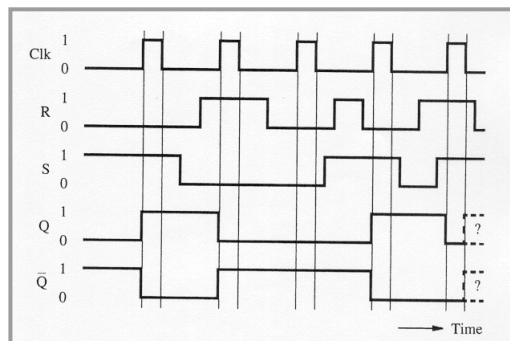

February 6, 2012

ECE 152A - Digital Design Principles

24

The Gated SR Latch (cont)

- NAND Implementation

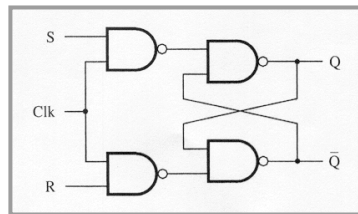

February 6, 2012

ECE 152A - Digital Design Principles

25

The Gated Data (D) Latch

- NAND Implementation of transparent D latch

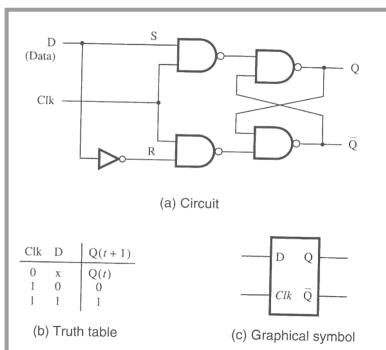

February 6, 2012

ECE 152A - Digital Design Principles

26

The Gated D Latch

■ Timing Diagram

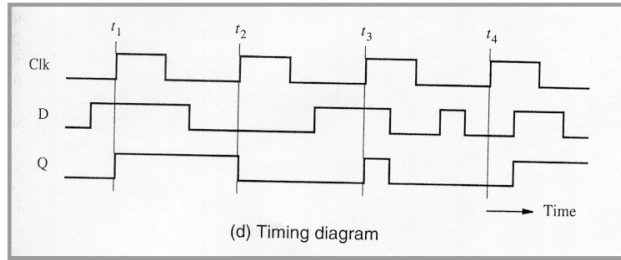

The Edge Triggered D Flip-Flop

■ The D Flip-Flop

- Input D, latched and passed to Q on clock edge
- Rising edge triggered or falling edge triggered
 - Characteristic table and function

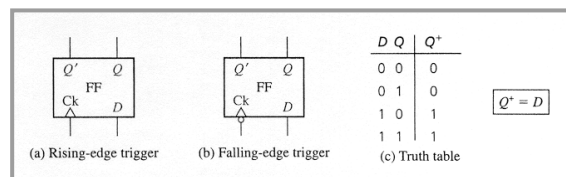

The Edge Triggered D Flip-Flop

- Most commonly used flip-flop
- Output follows input after clock edge
 - Q and Q* change only on clock edge
 - Timing diagram for negative edge triggered flip-flop

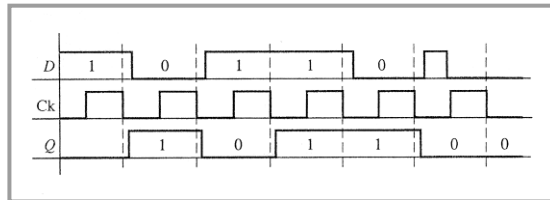

February 6, 2012

ECE 152A - Digital Design Principles

29

The D Flip-Flop

- State Table

PS (Q)	NS (Q ⁺)	
	D = 0	D = 1
0	0	1
1	0	1

February 6, 2012

ECE 152A - Digital Design Principles

30

The D Flip-Flop (cont)

■ State Diagram

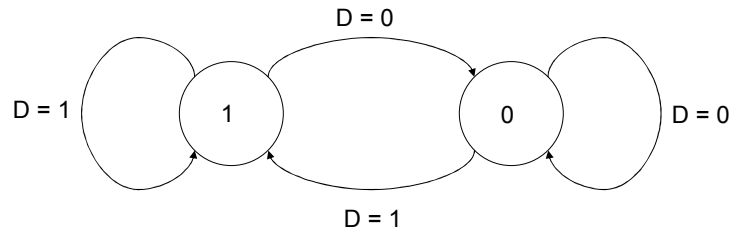

February 6, 2012

ECE 152A - Digital Design Principles

31

The Master-Slave D Flip-Flop

- Construct edge triggered flip-flop from 2 transparent latches
 - Many other topologies for edge triggered flip-flops
 - Falling edge triggered (below)

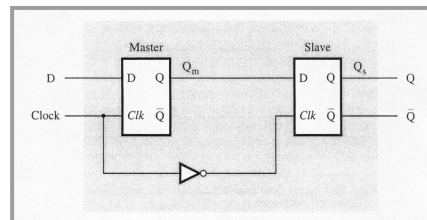

February 6, 2012

ECE 152A - Digital Design Principles

32

The Master-Slave D Flip-Flop (cont)

- Timing Diagram
 - Falling edge triggered

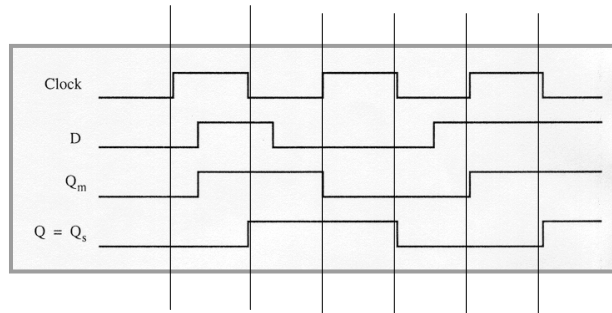

February 6, 2012

ECE 152A - Digital Design Principles

33

The Master-Slave D Flip-Flop (cont)

- A Second Timing Diagram
 - Rising edge triggered

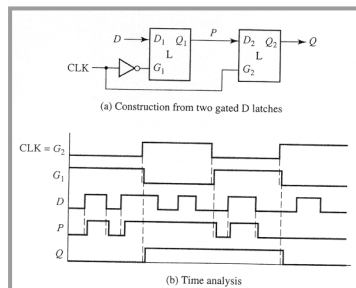

February 6, 2012

ECE 152A - Digital Design Principles

34

The Edge Triggered D Flip-Flop

- “True” Edge Triggered D Flip-Flop
 - Never transparent (unlike Master Slave)

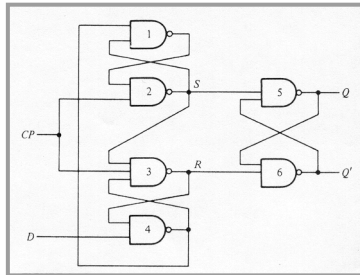

The Edge Triggered D Flip-Flop

- Operation of Flip-Flop

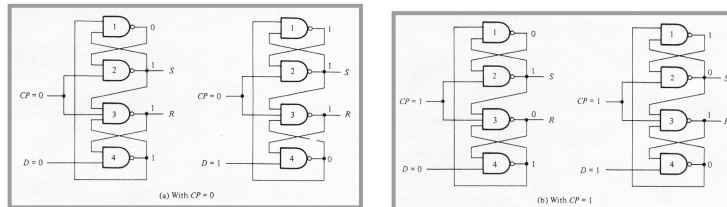

Types of D Flip-Flops

- Gated, Positive Edge and Negative Edge

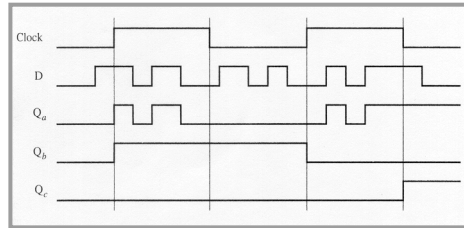
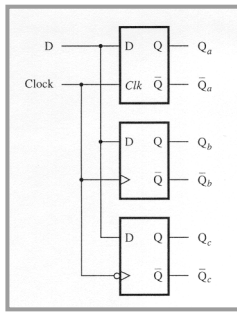

February 6, 2012

ECE 152A - Digital Design Principles

37

Timing Parameters

- CLK → Q
 - Delay from clock edge (CLK) to valid (Q, Q*) output
- Setup time t_{su}
 - Stable, valid data (D) before clock edge (CLK)
- Hold time t_{hold}
 - Stable, valid data (D) after clock edge (CLK)

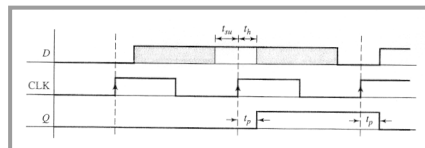

February 6, 2012

ECE 152A - Digital Design Principles

38

Maximum Frequency

- Maximum frequency (minimum clock period) for a digital system
 - $\text{CLK} \rightarrow \text{Q} + \text{propagation delay} + t_{su}$

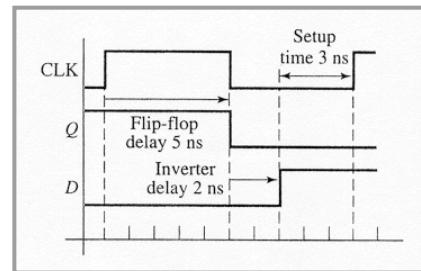
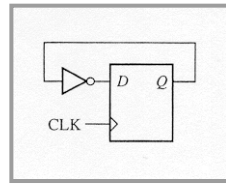

February 6, 2012

ECE 152A - Digital Design Principles

39

Counter Design with D Flip-Flops

- Design Example #1: Modulo 3 counter
 - $00 \rightarrow 01 \rightarrow 10 \downarrow$
 $\uparrow \leftarrow \leftarrow \leftarrow \leftarrow \leftarrow$
- Requires 2 flip-flops
 - One for each "state variable"

February 6, 2012

ECE 152A - Digital Design Principles

40

Counter Design with D Flip-Flops

■ State Diagram

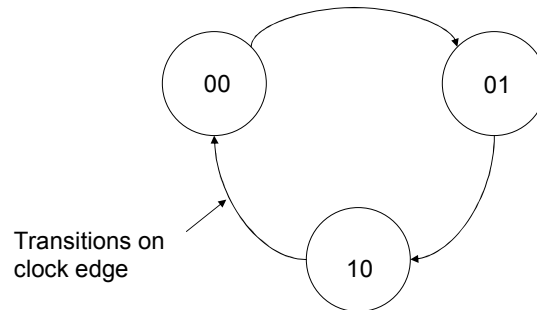

February 6, 2012

ECE 152A - Digital Design Principles

41

Counter Design with D Flip-Flops

■ State Table

PS		NS	
A	B	A ⁺	B ⁺
0	0	0	1
0	1	1	0
1	0	0	0
1	1	X	X

February 6, 2012

ECE 152A - Digital Design Principles

42

Counter Design with D Flip-Flops

■ Next State Maps

	B	0	1
A	0	0	1
1	0	0	X

$$A^+ = B$$

	B	0	1
A	0	1	0
1	0	0	X

$$B^+ = A'B'$$

Counter Design with D Flip-Flops

- Implementation with D Flip-Flops
- What are the D inputs to flip-flops A and B?
 - Recall characteristic equation for D flip-flop
 - $Q^+ = D$
 - Therefore, $A^+ = B \rightarrow D_A = B$
 - and... $B^+ = A'B' \rightarrow D_B = A'B'$

Counter Design with D Flip-Flops

- Implementation with positive edge triggered flip-flops

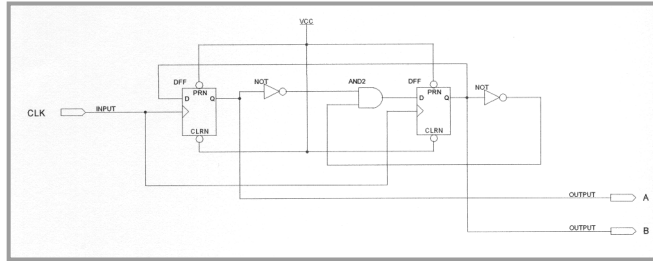

February 6, 2012

ECE 152A - Digital Design Principles

45

Counter Design with D Flip-Flops

- Implementation with positive edge triggered flip-flops
 - Timing diagram

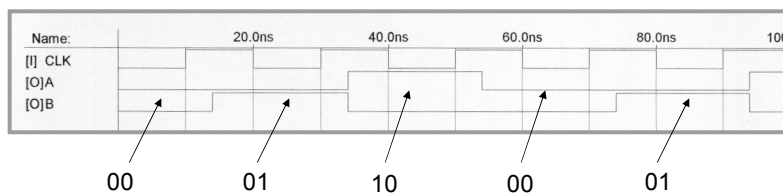

February 6, 2012

ECE 152A - Digital Design Principles

46

Counter Design with D Flip-Flops

- Design Example #2:
 - Modulo 3 counter with up/down* input
 - Counter counts up with input = 1 and down with input = 0
 - Implement with D flip-flops

February 6, 2012

ECE 152A - Digital Design Principles

47

Counter Design with D Flip-Flops

- State diagram

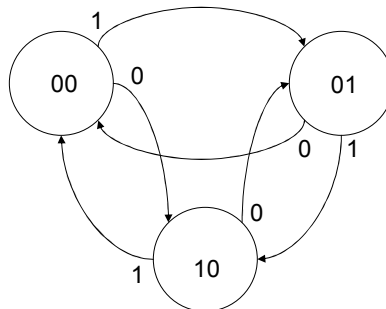

February 6, 2012

ECE 152A - Digital Design Principles

48

Counter Design with D Flip-Flops

■ State table

U	A	B	A ⁺	B ⁺
0	0	0	1	0
0	0	1	0	0
0	1	0	0	1
0	1	1	X	X
1	0	0	0	1
1	0	1	1	0
1	1	0	0	0
1	1	1	X	X

Counter Design with D Flip-Flops

■ Next state maps and flip-flop inputs

		AB			
		00	01	11	10
U	0	1		X	
	1		1	X	

$$A^+ = D_A = UB + U'A'B'$$

		AB			
		00	01	11	10
U	0			X	1
	1	1		X	

$$B^+ = D_B = U'A + UA'B'$$