

Frequency Domain Processing



Frequency domain processing

- Homomorphic filtering

Recap: Fig 4.1

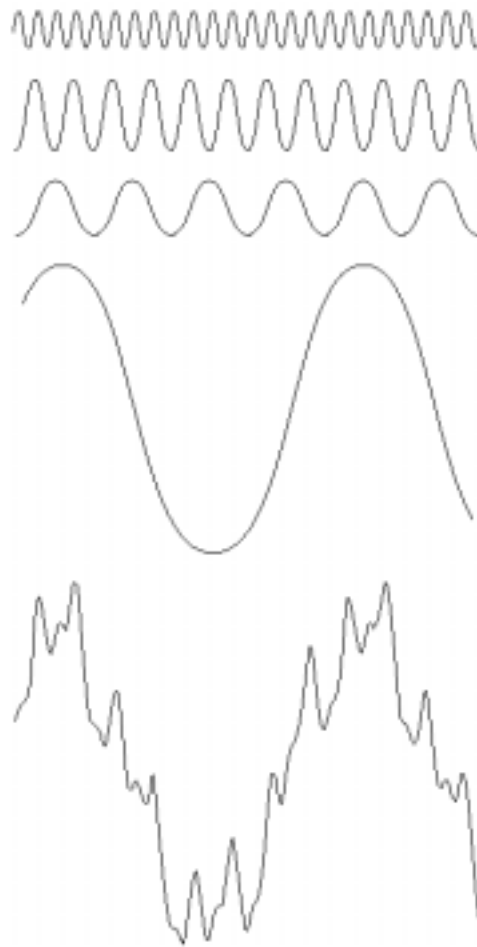
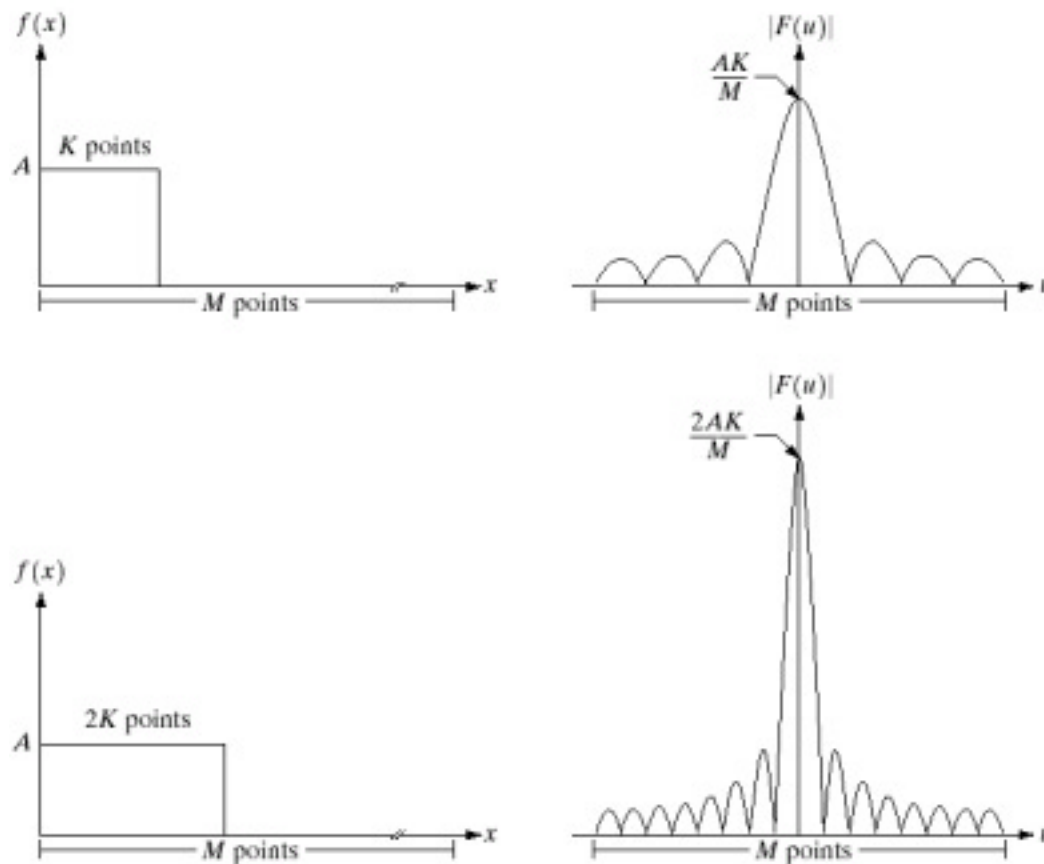

FIGURE 4.1 The function at the bottom is the sum of the four functions above it. Fourier's idea in 1807 that periodic functions could be represented as a weighted sum of sines and cosines was met with skepticism.

An example: Fig 4.2



a b
c d

FIGURE 4.2 (a) A discrete function of M points, and (b) its Fourier spectrum. (c) A discrete function with twice the number of nonzero points, and (d) its Fourier spectrum.

Basic Scheme

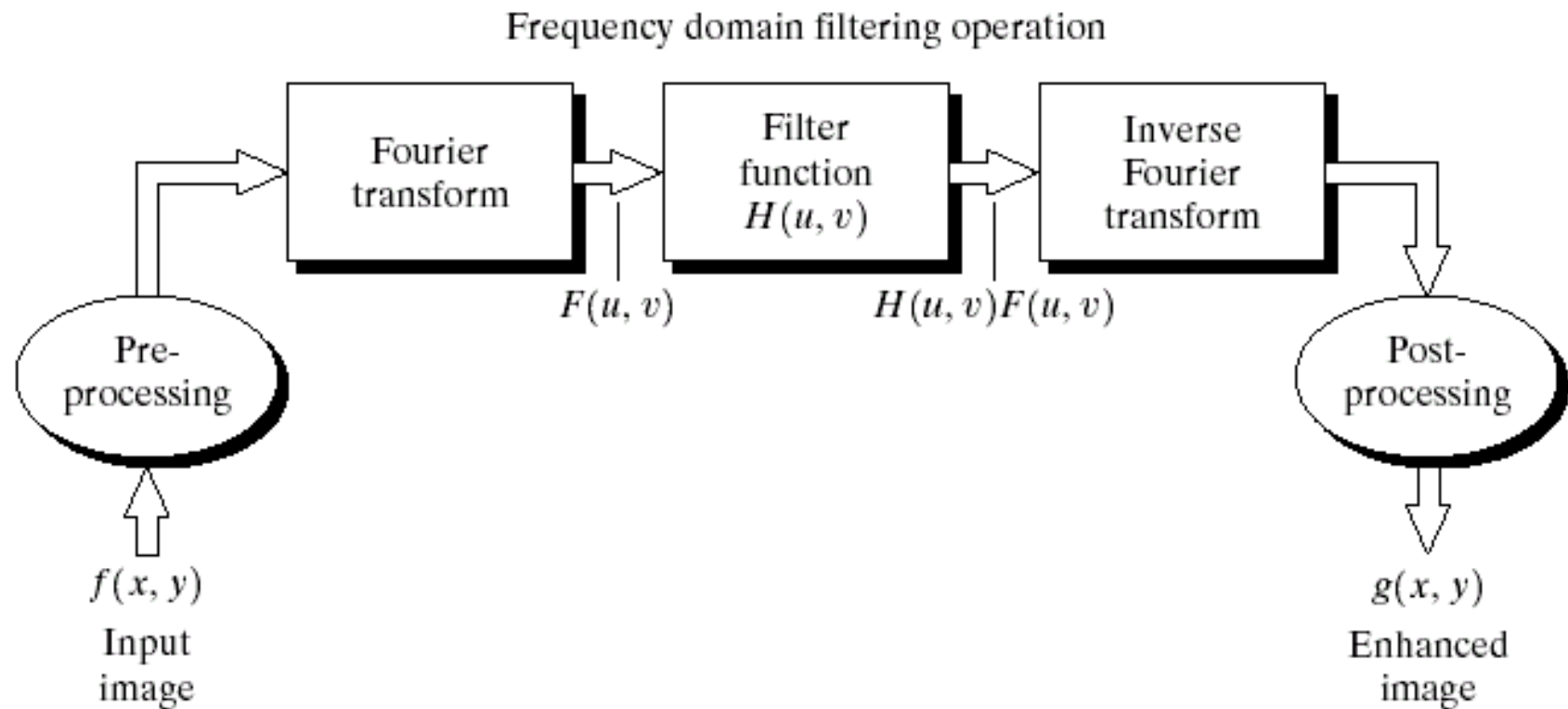
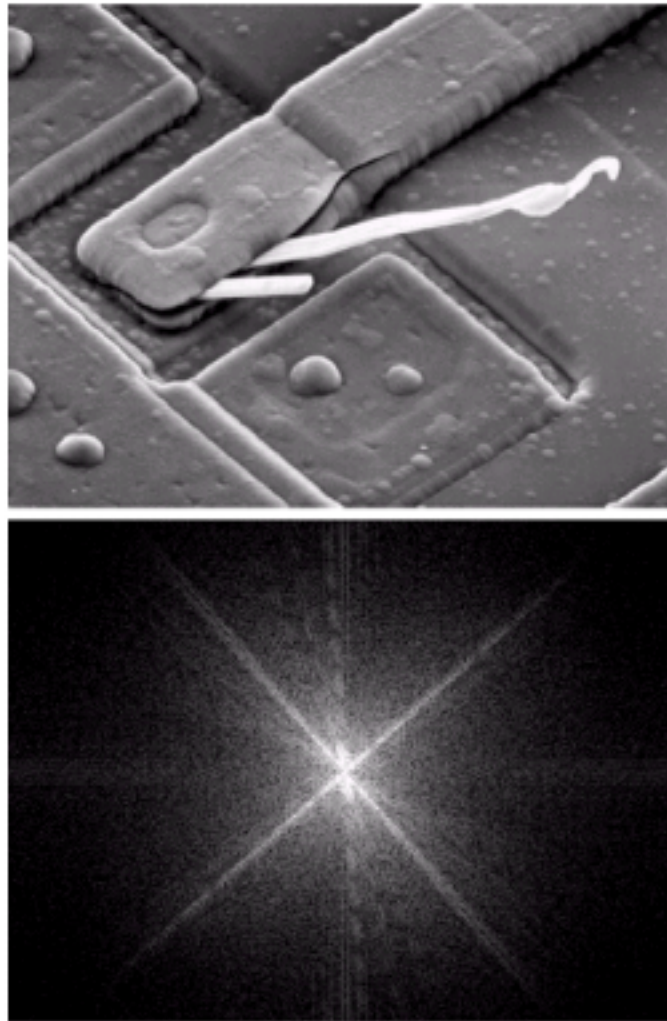

FIGURE 4.5 Basic steps for filtering in the frequency domain.

An image and its DFT: Fig 4.4



a
b

FIGURE 4.4

(a) SEM image of a damaged integrated circuit.
(b) Fourier spectrum of (a).
(Original image courtesy of Dr. J. M. Hudak, Brockhouse Institute for Materials Research, McMaster University, Hamilton, Ontario, Canada.)

filtering

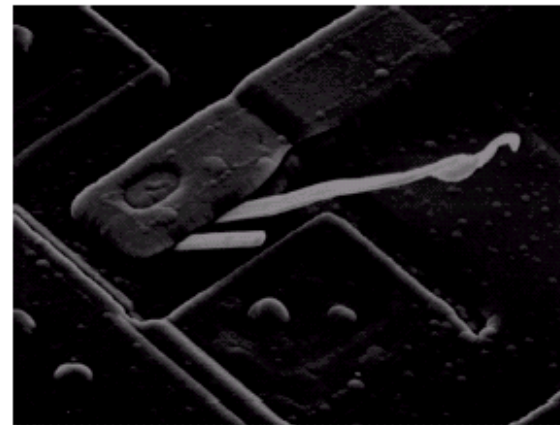
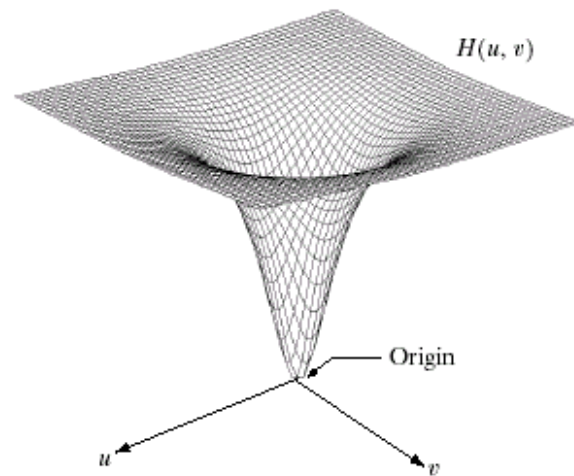
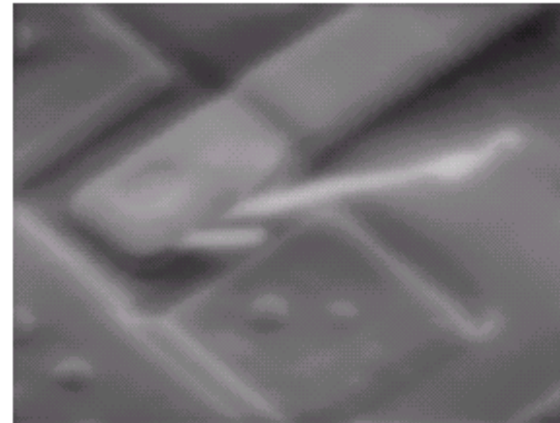
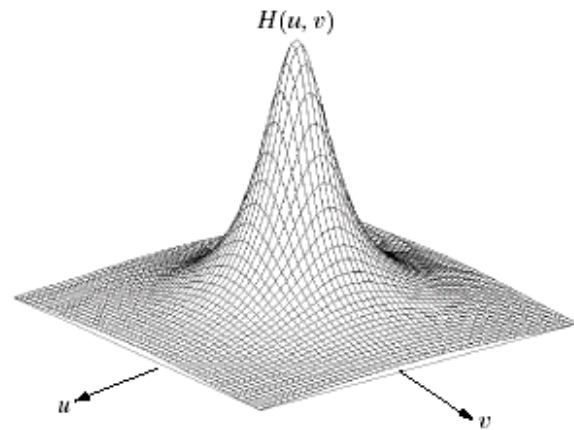

a	b
c	d

FIGURE 4.7 (a) A two-dimensional lowpass filter function. (b) Result of lowpass filtering the image in Fig. 4.4(a). (c) A two-dimensional highpass filter function. (d) Result of highpass filtering the image in Fig. 4.4(a).

Ideal Low Pass Filter

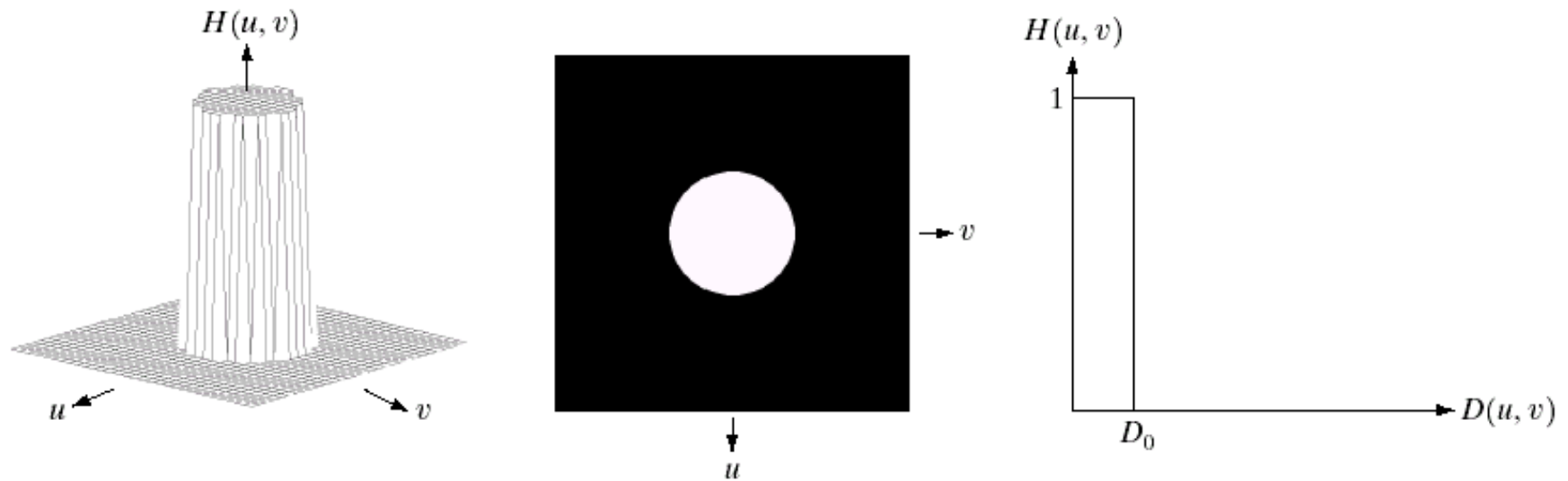

a b c

FIGURE 4.10 (a) Perspective plot of an ideal lowpass filter transfer function. (b) Filter displayed as an image. (c) Filter radial cross section.

An image: Fig 4.11

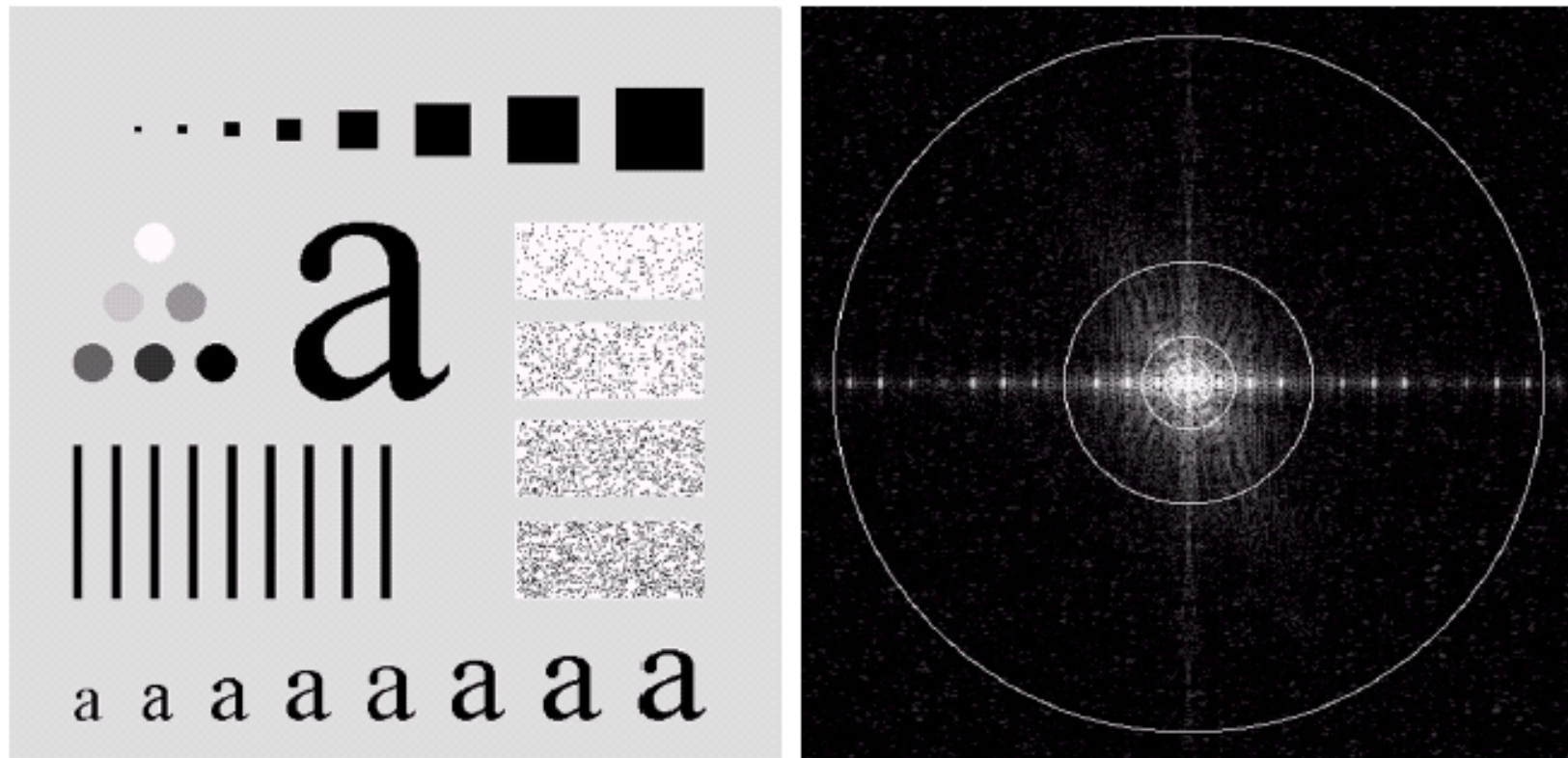

a b

FIGURE 4.11 (a) An image of size 500×500 pixels and (b) its Fourier spectrum. The superimposed circles have radii values of 5, 15, 30, 80, and 230, which enclose 92.0, 94.6, 96.4, 98.0, and 99.5% of the image power, respectively.

LPF at different cut-off frequencies

Notice the
“ringing”
in b-f.



FIGURE 4.12 (a) Original image. (b)–(f) Results of ideal lowpass filtering with cutoff frequencies set at radii values of 5, 15, 30, 80, and 230, as shown in Fig. 4.11(b). The power removed by these filters was 8, 5.4, 3.6, 2, and 0.5% of the total, respectively.

Butterworth LPF

LPF :

$$G(u, v) = H(u, v) F(u, v)$$

$$H(u, v) = \begin{cases} 1 & \text{if } D(u, v) \leq D_0 \\ 0 & \text{if } D(u, v) > D_0 \end{cases}$$

$$D(u, v) = \sqrt{u^2 + v^2} \quad (\text{Circularly symmetric})$$

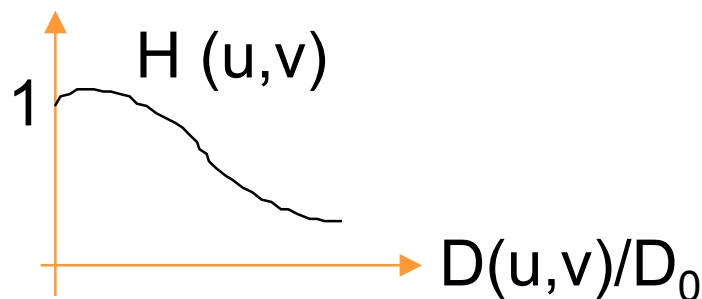
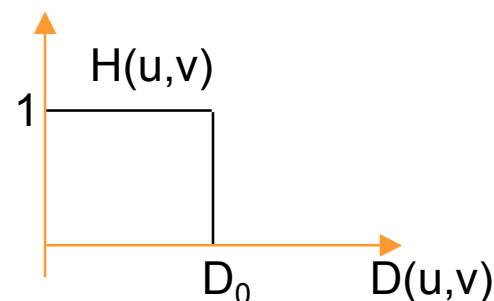

Butterworth filter:

$$H(u, v) = \frac{1}{1 + [D(u, v) / D_0]^{2n}}$$

“Ringing”: Fig 4.13

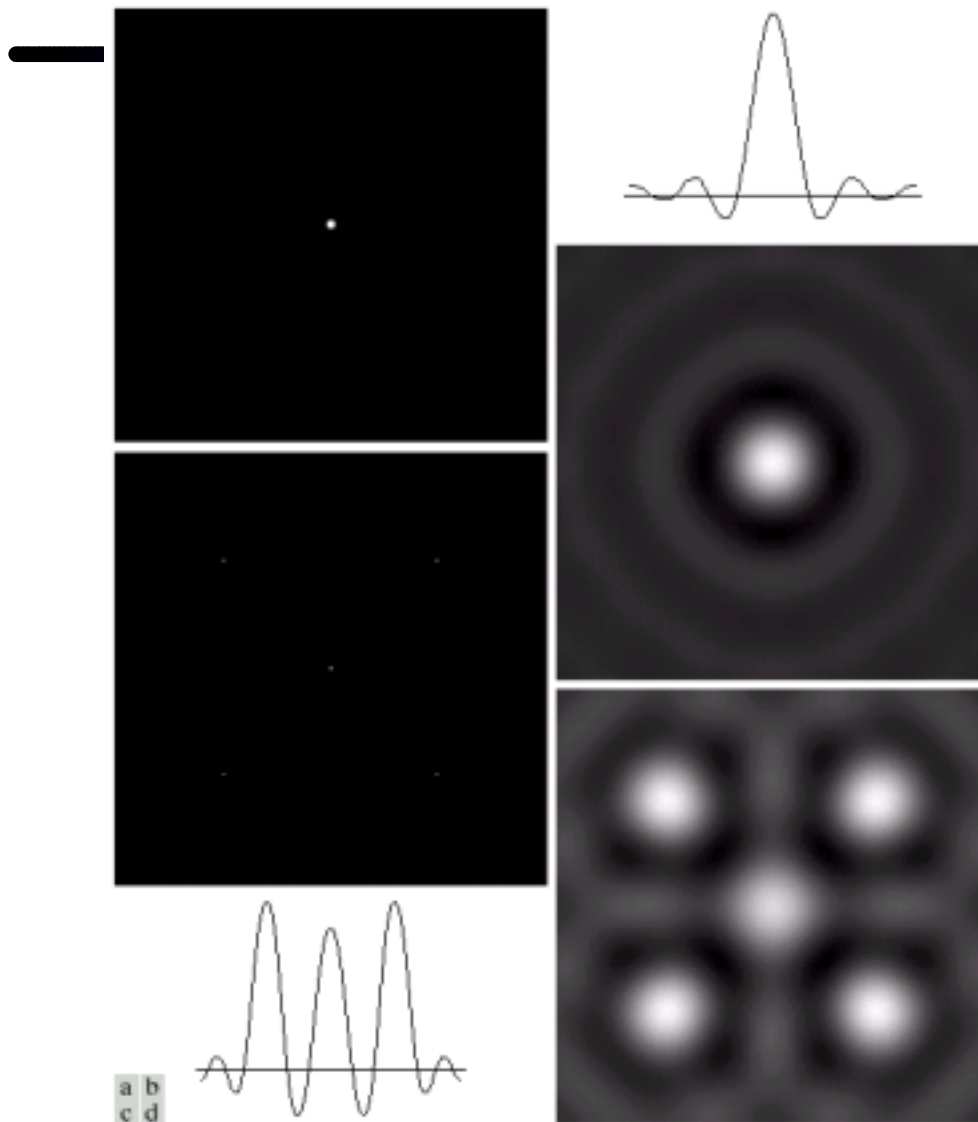
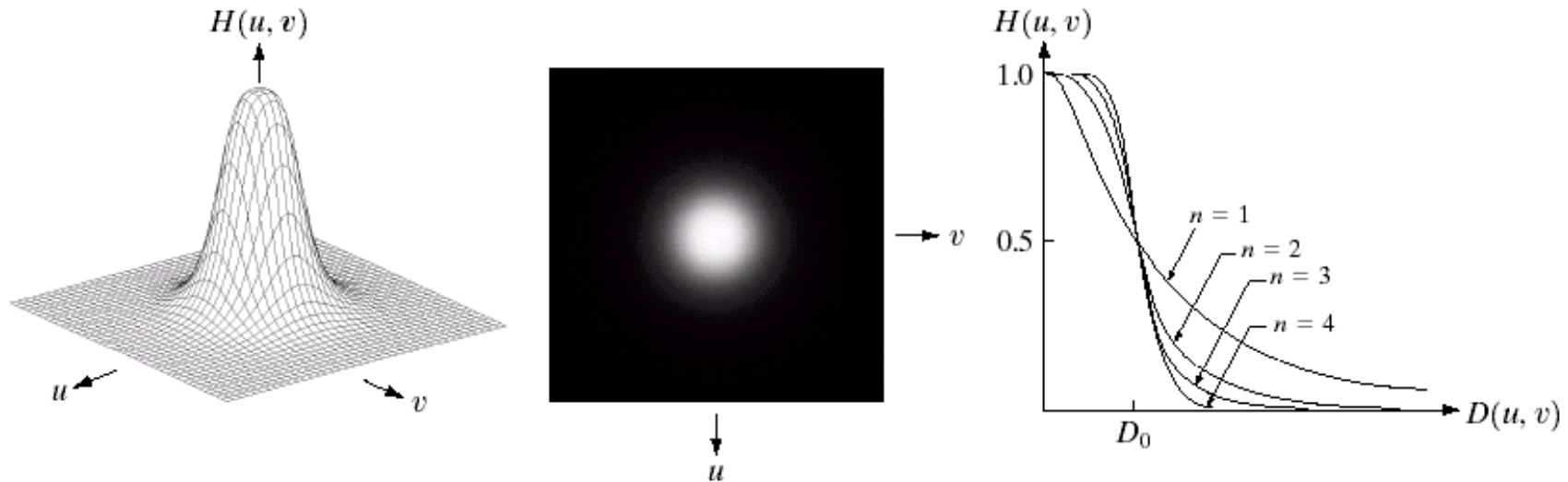

FIGURE 4.13 (a) A frequency-domain ILPF of radius 5. (b) Corresponding spatial filter (note the ringing). (c) Five impulses in the spatial domain, simulating the values of five pixels. (d) Convolution of (b) and (c) in the spatial domain.

Butterworth filter: Fig 4.14



a b c

FIGURE 4.14 (a) Perspective plot of a Butterworth lowpass filter transfer function. (b) Filter displayed as an image. (c) Filter radial cross sections of orders 1 through 4.

LPF example again



a
b
c
d
e
f

FIGURE 4.15 (a) Original image. (b)–(f) Results of filtering with BLPFs of order 2, with cutoff frequencies at radii of 5, 15, 30, 80, and 230, as shown in Fig. 4.11(b). Compare with Fig. 4.12.

Spatial representation of BWF

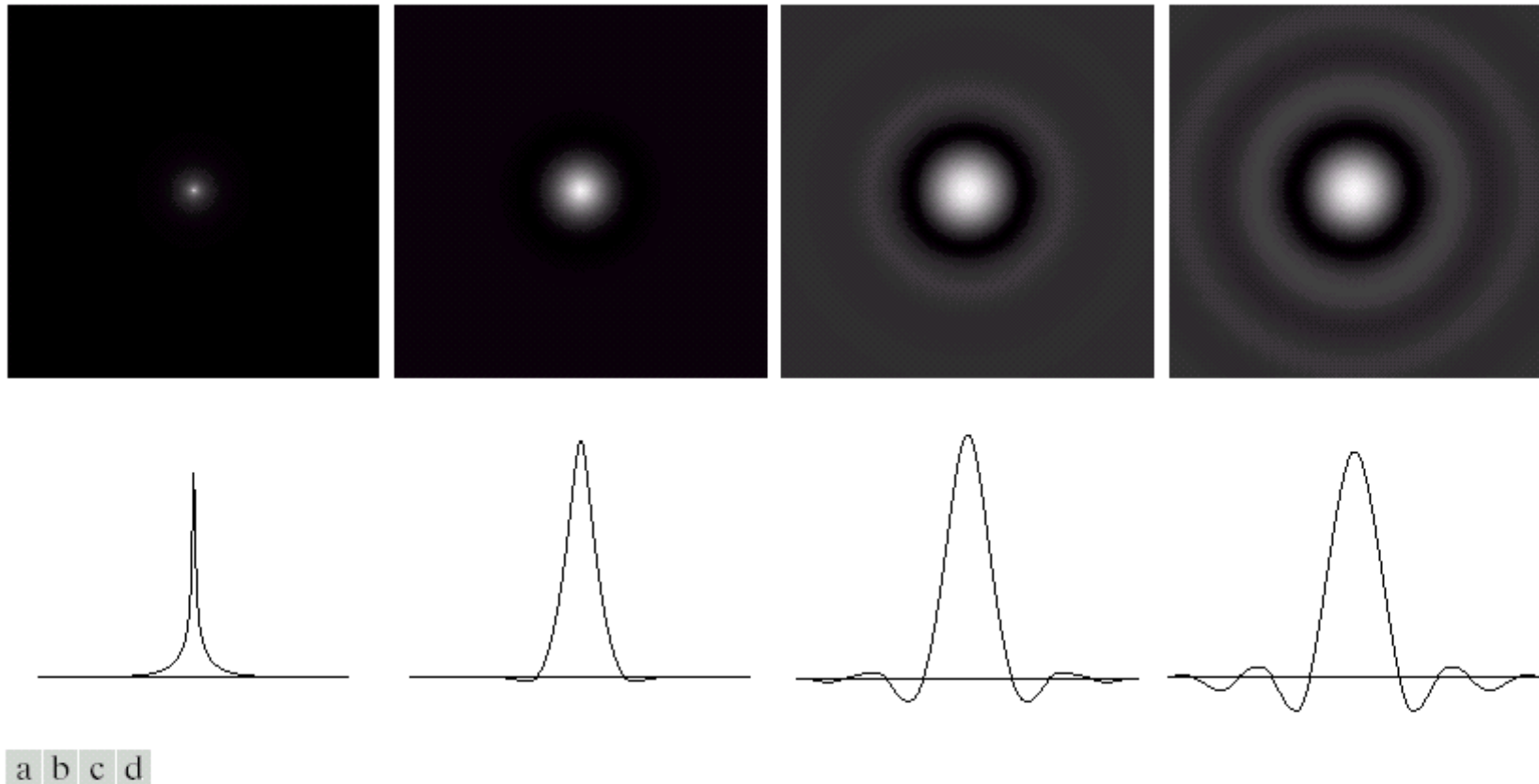
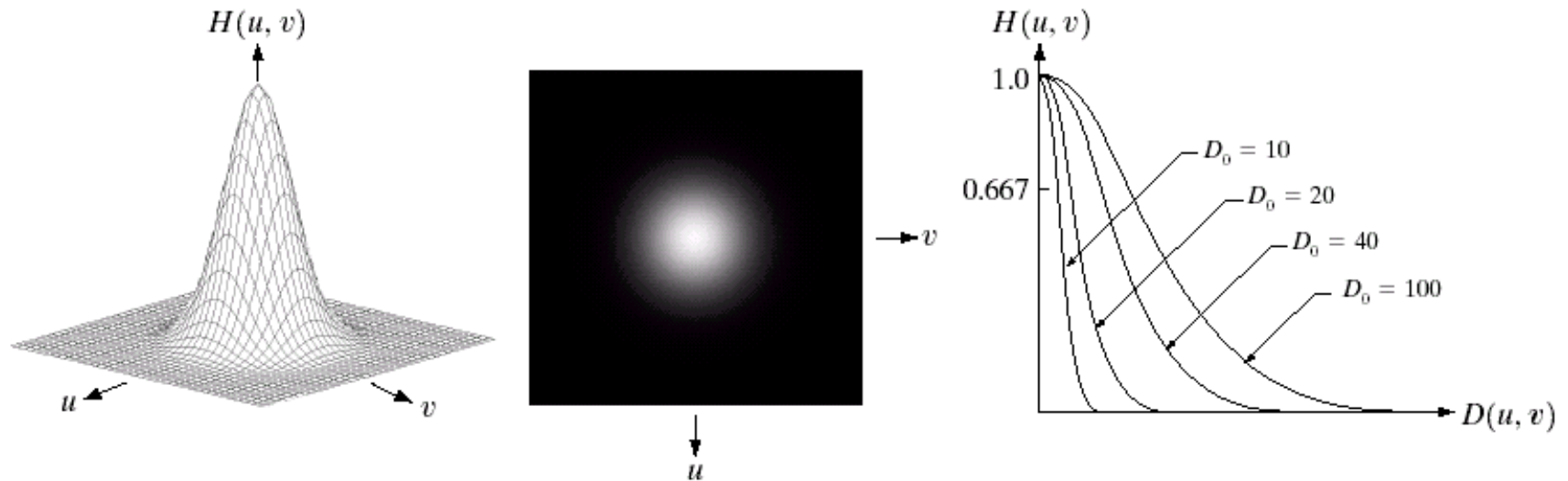

FIGURE 4.16 (a)–(d) Spatial representation of BLPFs of order 1, 2, 5, and 20, and corresponding gray-level profiles through the center of the filters (all filters have a cutoff frequency of 5). Note that ringing increases as a function of filter order.

Gaussian LPF



a b c

FIGURE 4.17 (a) Perspective plot of a GLPF transfer function. (b) Filter displayed as an image. (c) Filter radial cross sections for various values of D_0 .

$$H(u, v) = \exp(-D^2(u, v) / 2\sigma^2)$$

Filtering using GLPF



FIGURE 4.18 (a) Original image. (b)–(f) Results of filtering with Gaussian lowpass filters with cutoff frequencies set at radii values of 5, 15, 30, 80, and 230, as shown in Fig. 4.11(b). Compare with Figs. 4.12 and 4.15.

a b
c d
e f

Another example

a b

FIGURE 4.19

(a) Sample text of poor resolution (note broken characters in magnified view).
(b) Result of filtering with a GLPF (broken character segments were joined).

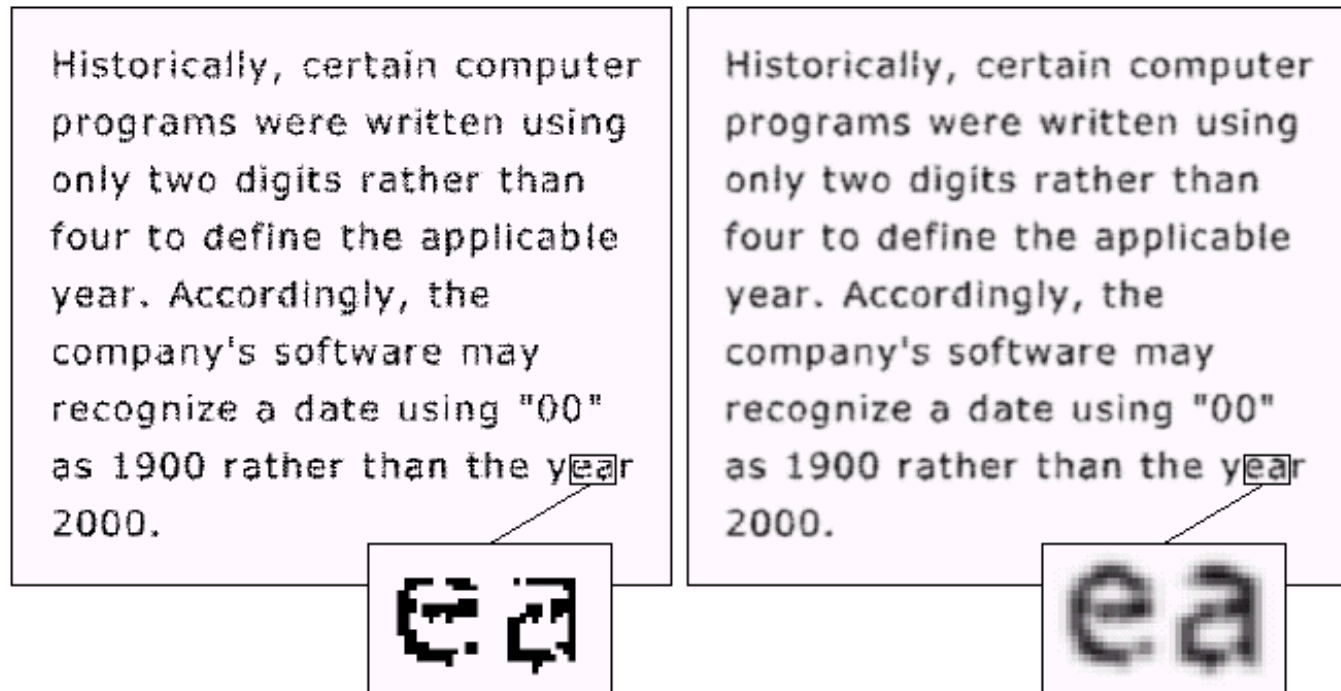

Frequency domain processing

HPF

$$\text{HPF : } H(u, v) = \begin{cases} 0 & \text{if } D(u, v) \leq D_0 \\ 1 & \text{if } D(u, v) > D_0 \end{cases}$$

Butterworth filter:

$$H(u, v) = \frac{1}{1 + [D_0 / D(u, v)]^{2n}}$$

HPF: Fig 4.22

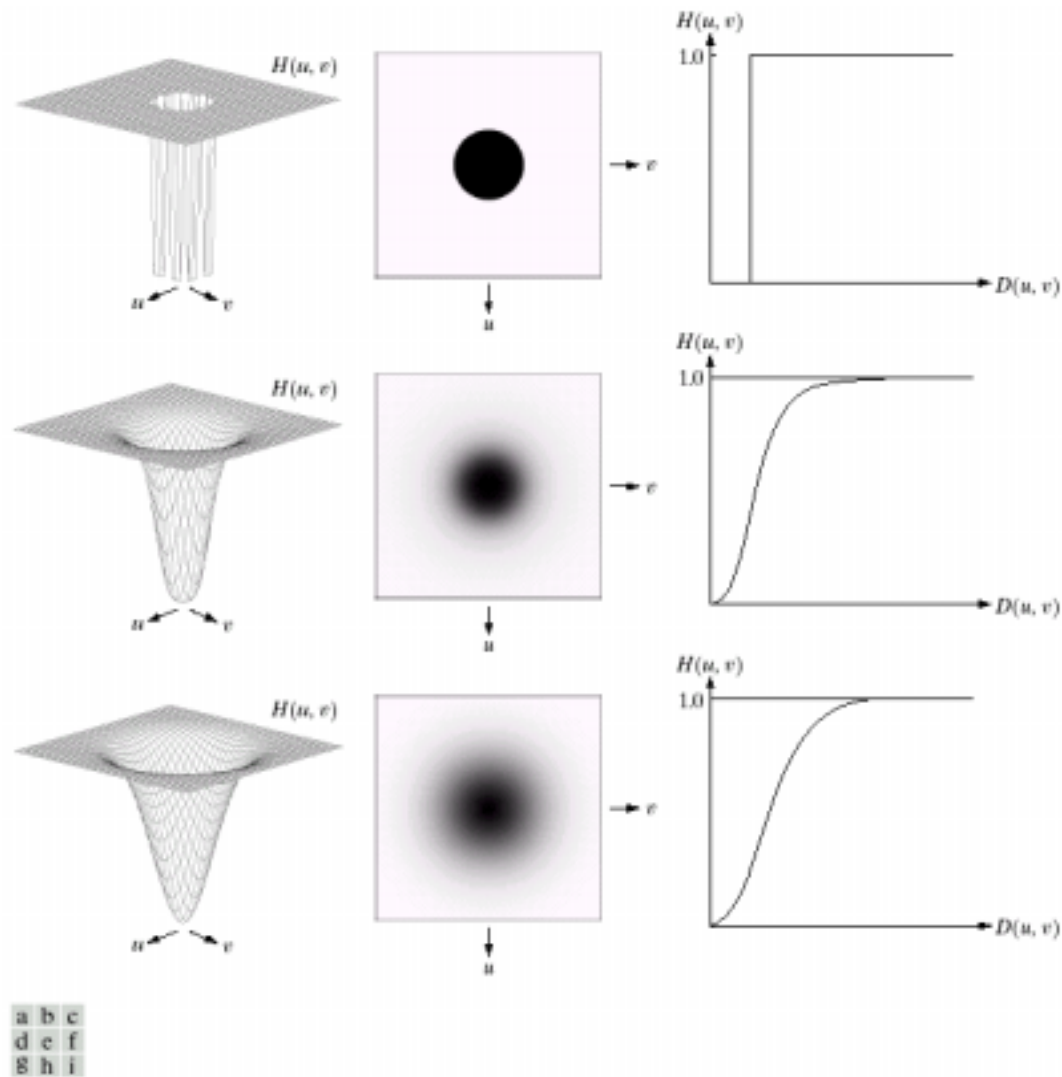

FIGURE 4.22 Top row: Perspective plot, image representation, and cross section of a typical ideal highpass filter. Middle and bottom rows: The same sequence for typical Butterworth and Gaussian highpass filters.

Spatial representation of HPF

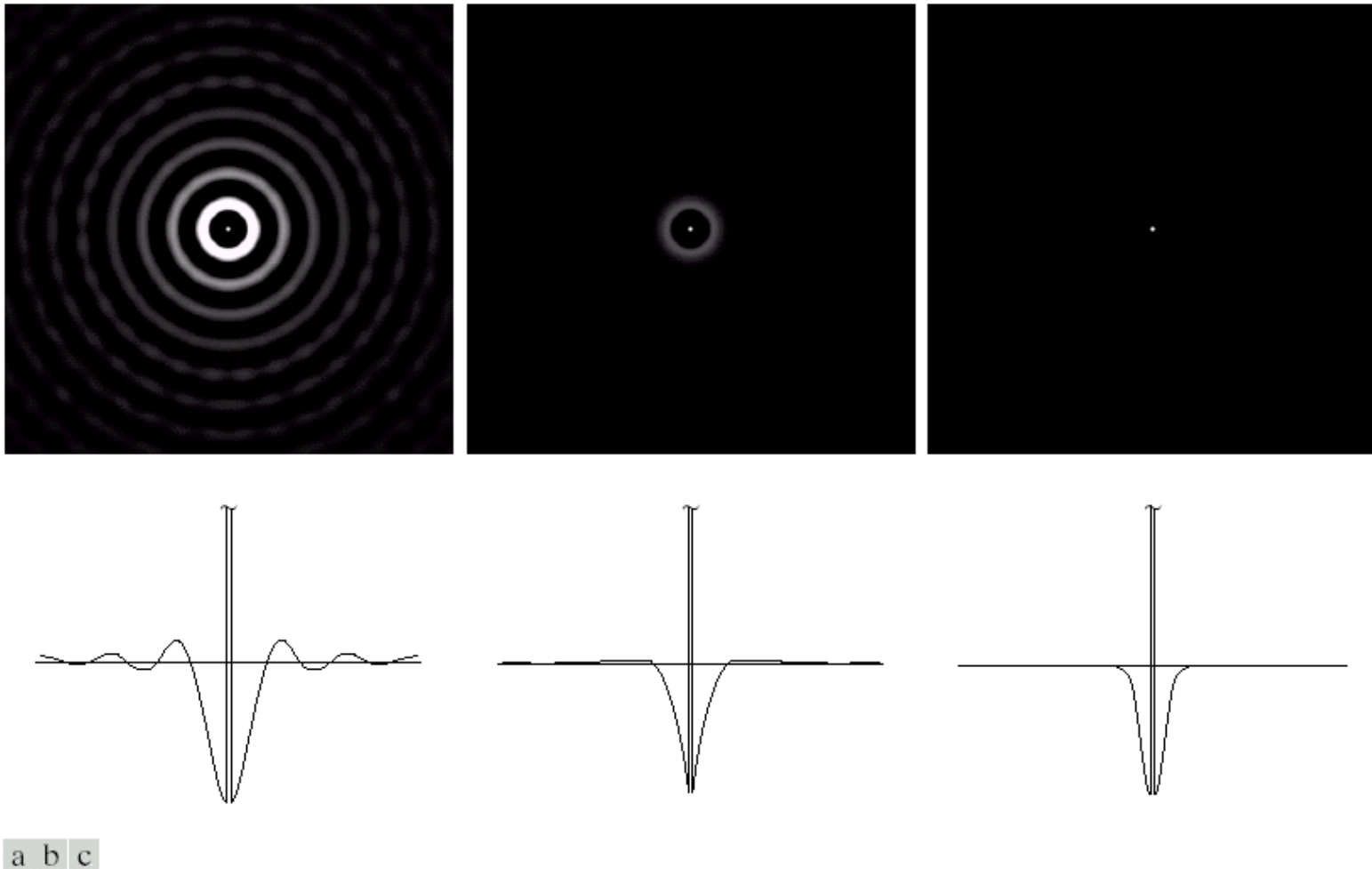
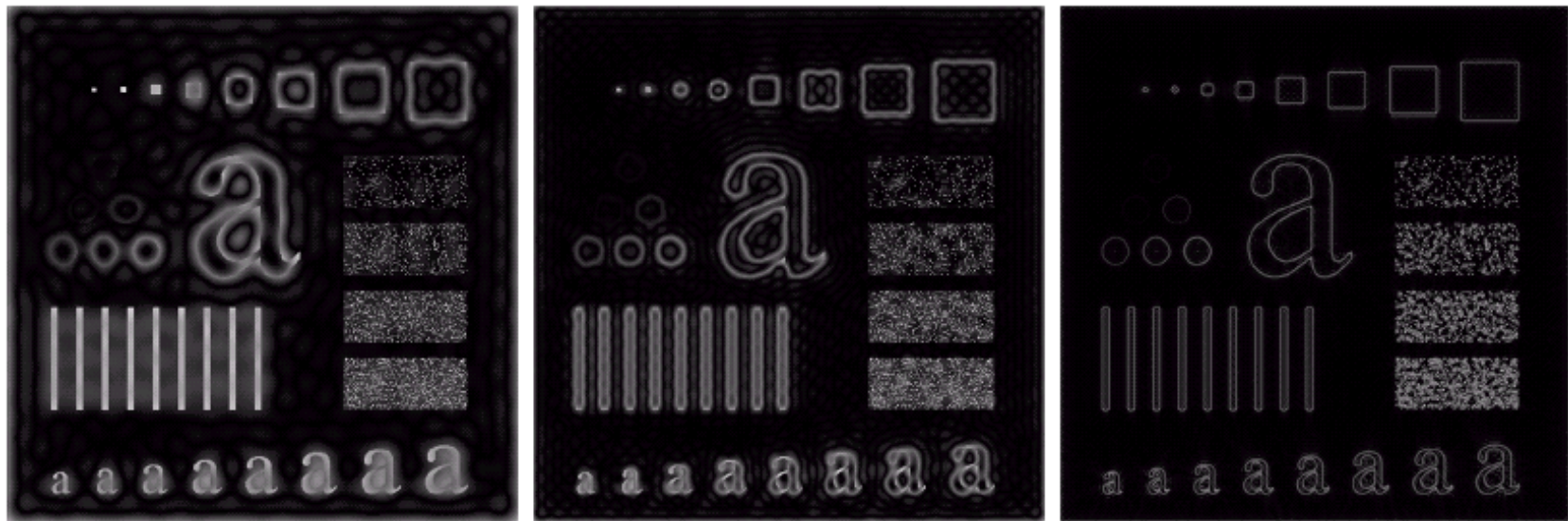

FIGURE 4.23 Spatial representations of typical (a) ideal, (b) Butterworth, and (c) Gaussian frequency domain highpass filters, and corresponding gray-level profiles.

Ideal HPF



a b c

FIGURE 4.24 Results of ideal highpass filtering the image in Fig. 4.11(a) with $D_0 = 15, 30,$ and $80,$ respectively. Problems with ringing are quite evident in (a) and (b).

BWF

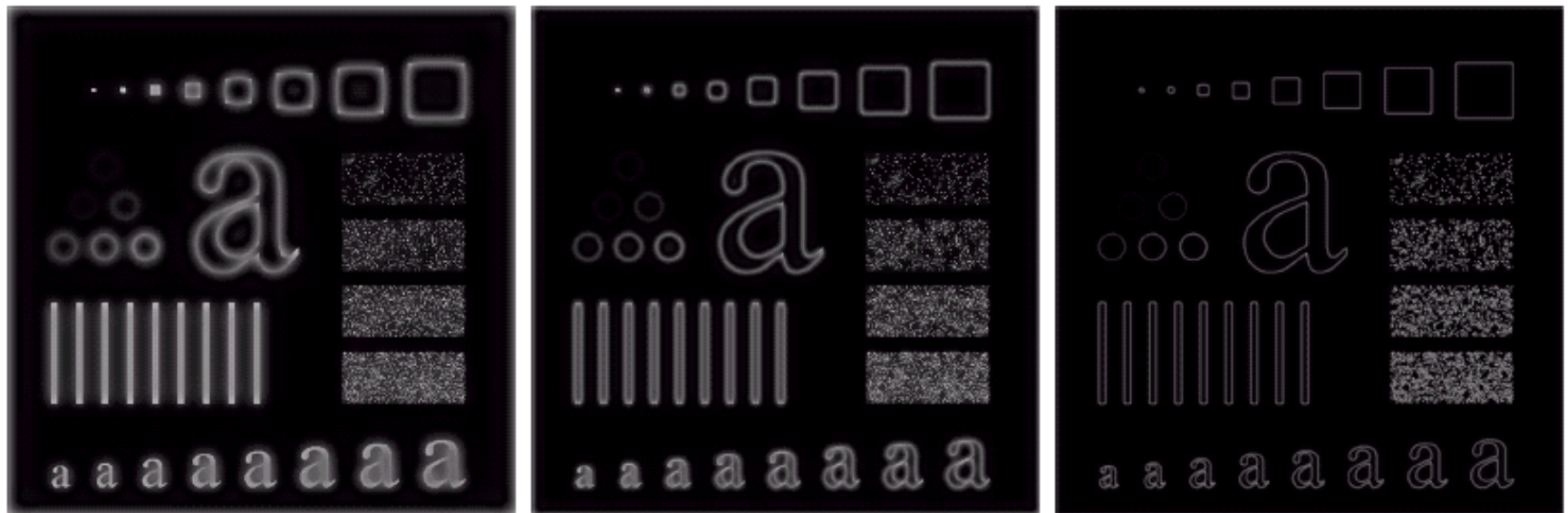

a b c

FIGURE 4.25 Results of highpass filtering the image in Fig. 4.11(a) using a BHPF of order 2 with $D_0 = 15$, 30, and 80, respectively. These results are much smoother than those obtained with an ILPF.

GHPF



a b c

FIGURE 4.26 Results of highpass filtering the image of Fig. 4.11(a) using a GHPF of order 2 with $D_0 = 15$, 30, and 80, respectively. Compare with Figs. 4.24 and 4.25.

Homomorphic filtering

Consider $f(x,y) = i(x,y) \cdot r(x,y)$

 ↑ ↑
 Illumination Reflectance

Now $\mathcal{F}\{f(x,y)\} \neq \mathcal{F}\{i \cdot r\}$

So cannot operate on individual components directly

Let $z(x,y) = \ln f(x,y) = \ln i(x,y) + \ln r(x,y)$

$\mathcal{F}\{z(x,y)\} = \mathcal{F}\{\ln i\} + \mathcal{F}\{\ln r\}$

$Z(u,v) = I + R$; Let $S(u,v) = HZ = HI + HR$

$s(x,y) = \mathcal{F}^{-1}\{HI\} + \mathcal{F}^{-1}\{HR\}$

Let $i'(x,y) = \mathcal{F}^{-1}\{HI\}$; $r'(x,y) = \mathcal{F}^{-1}\{HR\}$

Homomorphic filtering (contd.)

$$\therefore s(x, y) = i' + r'$$

$$g(x, y) = \exp (s(x, y))$$

$$= \exp i' + \exp r'$$

$$= i_o(x, y) r_o(x, y)$$

In practice: $i \longrightarrow$ slowly varying \Rightarrow LF
 $r \longrightarrow$ fast varying \Rightarrow HF

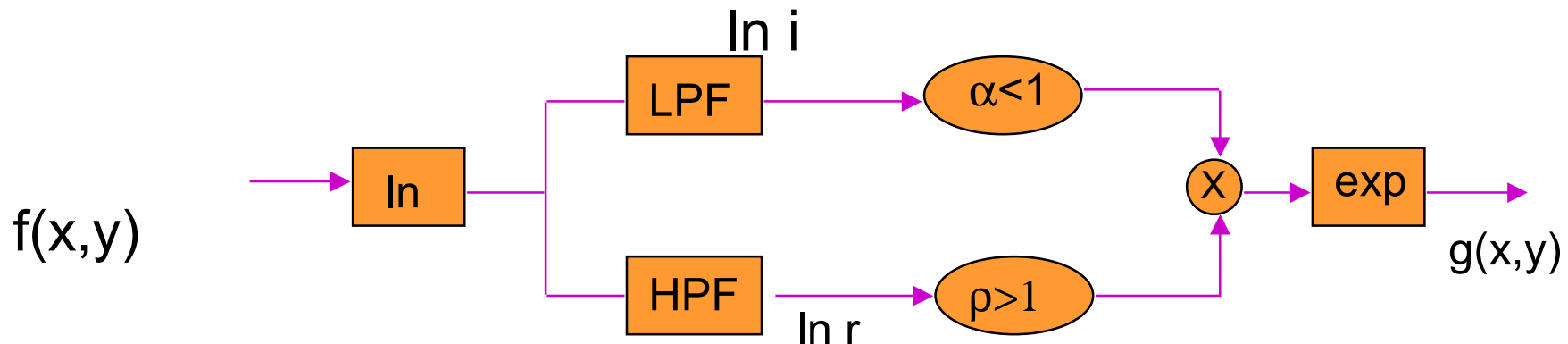

Homomorphic filtering (cont.)

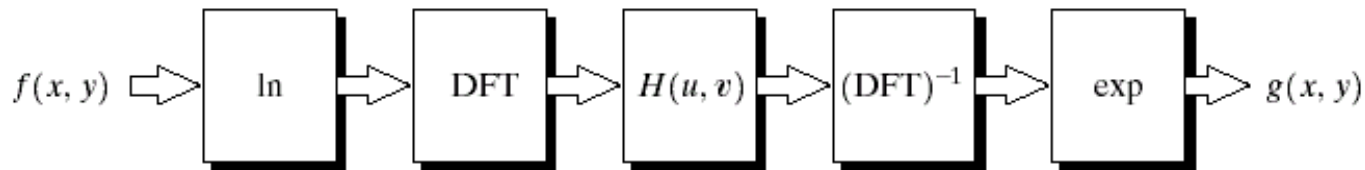

FIGURE 4.31
Homomorphic filtering approach for image enhancement.

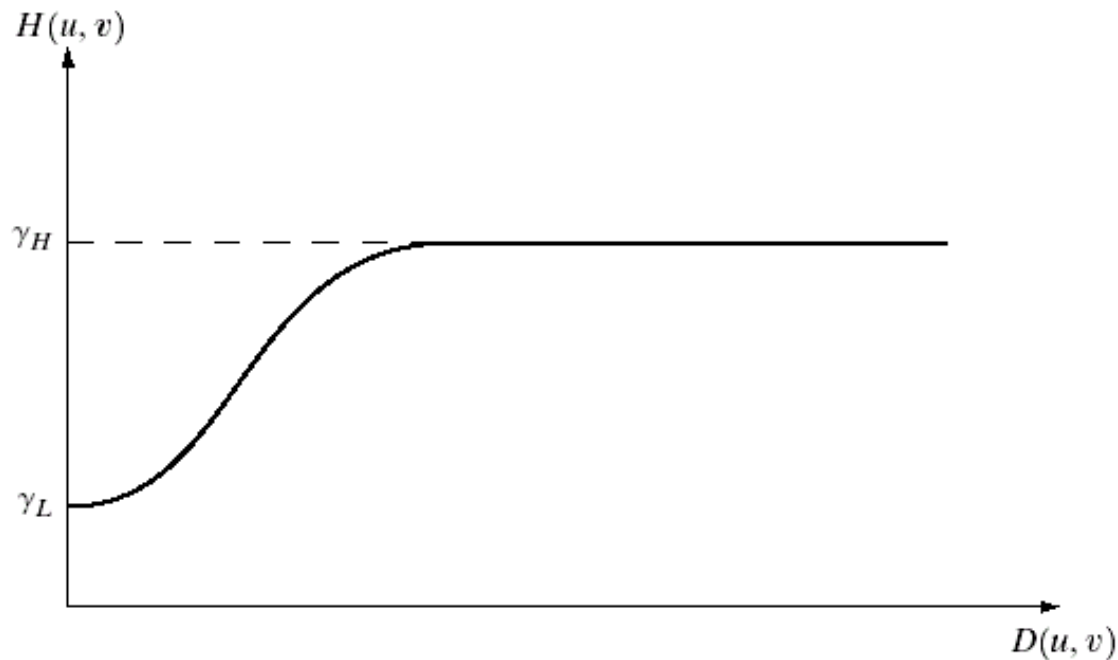

FIGURE 4.32
Cross section of a circularly symmetric filter function. $D(u, v)$ is the distance from the origin of the centered transform.

An example

a b

FIGURE 4.33
(a) Original image. (b) Image processed by homomorphic filtering (note details inside shelter). (Stockham.)

