



Lecture 14: Dispersion Compensation



Overview of Dispersion and Dispersion Compensation

Point-to-Point Fiber Transmission



- ⇒ Key aspects of point-to-point fiber transmission
 - ⇒ Optical modulation (we have covered already)
 - ⇒ Noise in optical systems & Receiver sensitivity (This lecture)
 - ⇒ Attenuation/loss & link power budget (This lecture)
 - ⇒ Linear effects in fiber transmission (This lecture)
 - ⇒ Nonlinear effects in fiber transmission (Not covered in this class)

WDM Fiber Transmission Links

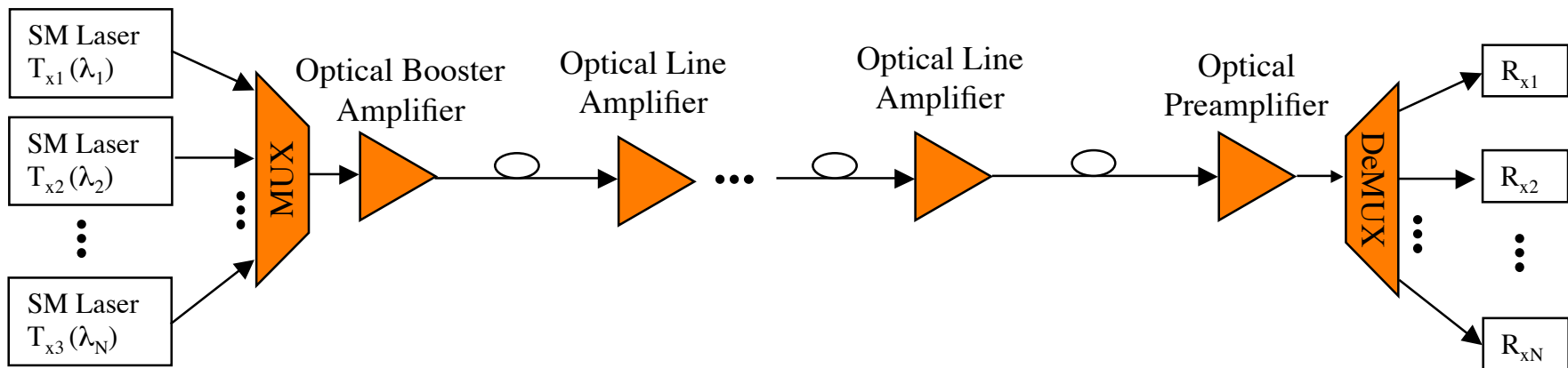

System Design Issues



- ⇒ Receiver sensitivity and degradation
- ⇒ Loss and optical amplification
- ⇒ Dispersion (chromatic, modal, polarization)
- ⇒ Signal-to-noise ratio (SNR)
- ⇒ Timing Jitter
- ⇒ Optical nonlinearities (fiber and amplifier)
- ⇒ Crosstalk
- ⇒ Power Penalties
- ⇒ Transient effects

Dispersion in Single Mode Fibers



- ⇒ Modal dispersion in multimode fibers is not present in single mode fiber (SMF)
- ⇒ However, other types of dispersion are present in SMF
 - ⇒ Material dispersion
 - ⇒ Waveguide dispersion
 - ⇒ Polarization mode dispersion
- ⇒ The first two effects fall under the term “Chromatic Dispersion”
- ⇒ The third effect is known as PMD
- ⇒ Dispersion can set the ultimate bit-rate limit in single mode fiber when loss and fiber nonlinearities are not dominant

Pulse Broadening

Assuming a Gaussian shaped input pulse and first order dispersion dominates ($\beta_2 \neq 0$)

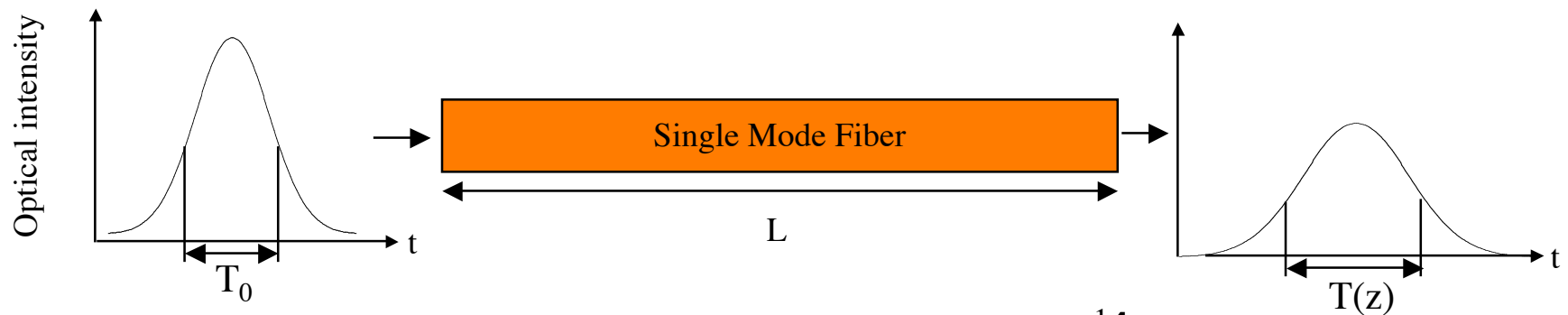

$$\frac{T(z)}{T_0} = \left[\left(1 + \frac{C\beta_2 z}{T_0^2} \right)^2 + \left(\frac{\beta_2 z}{T_0^2} \right)^2 \right]^{\frac{1}{2}}$$

➔ Define **Dispersion Length**

➔ An unchirped pulse ($C=0$) will broaden by a factor of $\sqrt{2}$ at $z = L_D$

Chromatic Dispersion

- ⇒ The two terms β_2 and β_3 of the previous equation are the derivative of the “mode propagation constant” $\beta(\omega)$
- ⇒ The meaning of $\beta(\omega)$ is clear when considering a single pulse propagation

$$\beta(\omega) = \frac{\omega n(\omega)}{c} = \beta_0 + \beta_1 \Delta\omega + \frac{1}{2} \beta_2 \Delta\omega^2 + \frac{1}{6} \beta_3 \Delta\omega^3$$

$$v_p = \frac{\omega_0}{\beta_0} = \frac{c}{n(\omega_0)}$$

$$v_g = \frac{1}{\beta_1} = \left(\left. \frac{d\beta}{d\omega} \right|_{\omega=\omega_0} \right)^{-1}$$

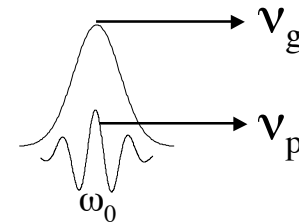

- ⇒ It turns out that, considering the dispersion term only
 - ⇒ The **phase velocity** (v_p) is the velocity of the center frequency ω_0 ,
 - ⇒ The **group velocity** (v_g) is the velocity of the center of the pulse. It is the value that determine the practical “velocity” of the transmission of the information (energy) in the fiber

Group Velocity Dispersion (GVD)

- ⇒ Group velocity (GVD) is frequency-dependent
- ⇒ Any communication signal (pulse) has a given bandwidth
 - ⇒ Different frequencies in pulse => Different group delays => Leads to pulse distortion
- ⇒ A more quantitative analysis can be carried out by considering that the fiber acts as a filter with the following transfer function:

$$A(z, \omega) = A(0, \omega) \cdot e^{-j \left(\frac{\beta_2}{2} \omega^2 + \frac{\beta_3}{2} \omega^3 \right) z}$$

- ⇒ The coefficient β_2 and β_3 are evaluated on the pulse central frequency/wavelength ω_0

Group Velocity Dispersion (GVD)

- ⇒ The previous equation can be exactly solved in some particular cases, among which the most important one is the propagation of a Gaussian pulse

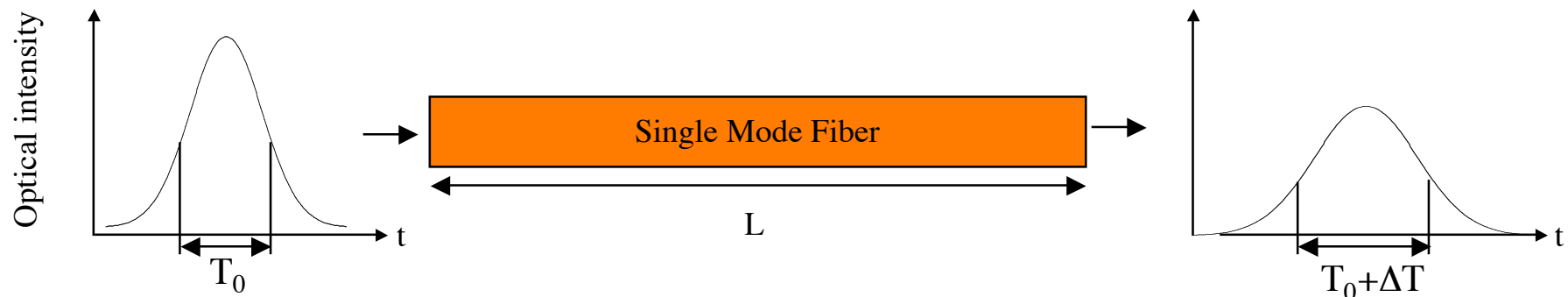

- ⇒ The Gaussian pulse is broadened after propagation of distance L by the amount:

$$\Delta T = L |\beta_2| \Delta \omega$$

- ⇒ where $\Delta \omega$ is the spectrum occupied by the pulse
⇒ and β_2 is the dispersion (material and waveguide) of the fiber

Dispersion parameters: β_2 and D

- ⇒ β_2 is called the “group velocity dispersion” GVD parameter
 - ⇒ It is expressed in units of ps²/km
- ⇒ From a mathematical point of view, it is easier to handle equations dealing with β_2 and optical frequency
- ⇒ It is also convenient to specify dispersion in terms of optical wavelength
- ⇒ The “D” parameter is

$$D = \frac{d}{d\lambda} \left(\frac{1}{v_g} \right) \approx -\frac{\lambda}{c} \frac{\partial n^2(\lambda)}{\partial \lambda^2}$$

- ⇒ D is called the “Dispersion parameter”, and it is expressed in units of ps/nm-km

Total Fiber Dispersion

- The waveguide geometry and design also introduces dispersion called “waveguide dispersion” which can be in the opposite sign as the material dispersion

$$D_{total} = D_{material} + D_{waveguide}$$

Waveguide dispersion can be combined with material dispersion to shift the zero dispersion frequency

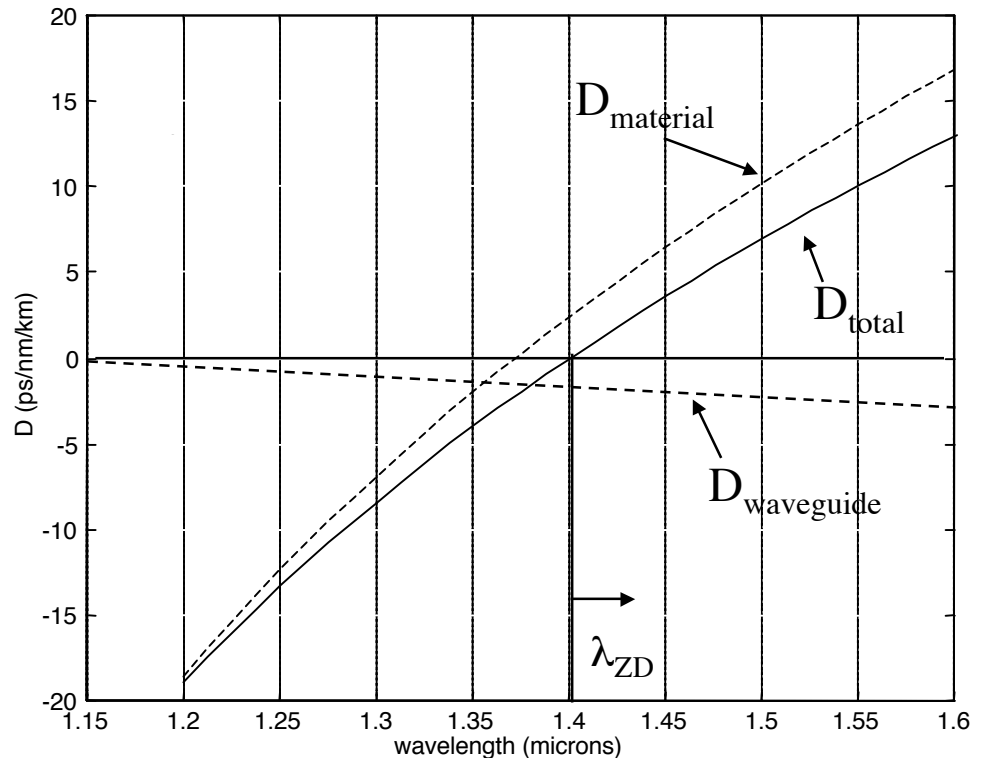

Dispersion Shifted and Flattened Fibers

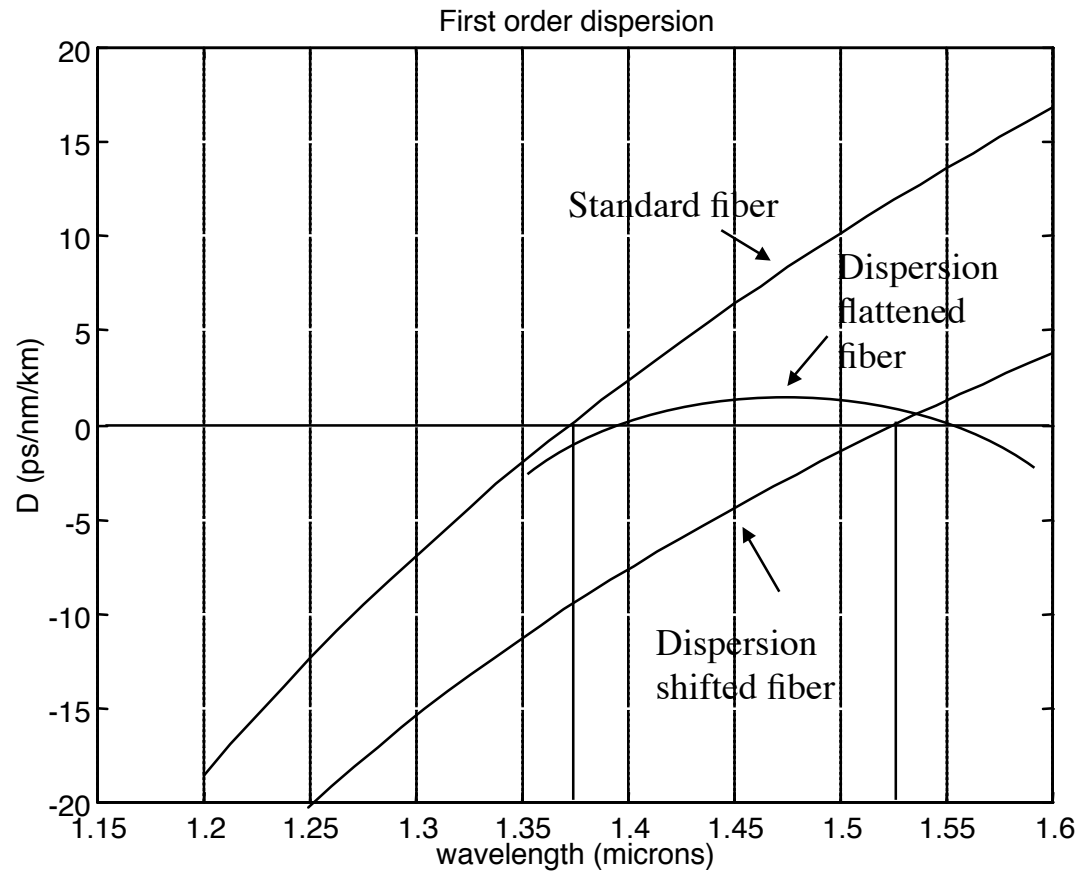

Higher Order Dispersion

If the wavelength is chosen such that $D=0$ or $\beta_2=0$, there is still dispersion described by the higher order dispersion terms S or β_3

$$S = \left(\frac{2\pi c}{\lambda^2} \right)^2 \beta_3$$

$$\beta_3 = \frac{d\beta_2}{d\omega}$$

The S parameters is relevant mostly for systems:

- Working close to a zero first order dispersion
- Using WDM (i.e. multiple wavelength)

Example:

A typical value of S for standard fiber at zero dispersion wavelength is $S=0.085 \text{ ps/km-nm}^2$. For dispersion-shifted fiber with $\lambda_{\text{ZD}}=1.55 \mu\text{m}$, a typical value of S is $S=0.05 \text{ ps/km-nm}^2$.

General Dispersion Formula

- ➔ If we take into account more realistic source and fiber effects †
 - ➔ we include β_3
 - ➔ source with a generic spectral width σ_ω

$$\frac{\sigma(z)}{\sigma_0} = \left[\left(1 + \frac{C\beta_2 z}{2\sigma_0^2} \right)^2 + (1 + V^2) \left(\frac{\beta_2 z}{2\sigma_0^2} \right)^2 + (1 + C^2 + V^2)^2 \frac{1}{2} \left(\frac{\beta_3 z}{4\sigma_0^3} \right)^2 \right]^{\frac{1}{2}}$$

Where $V = 2\sigma_0\sigma_\omega$

- ⇒ This formula can be used to derive dispersion limits in several different transmission scenarios

†D. Marcuse, Applied Optics, Vol. 19, p. 1653, 1980 and Vol. 20, p. 3573, 1981.

Dispersion Bit Rate Limitations

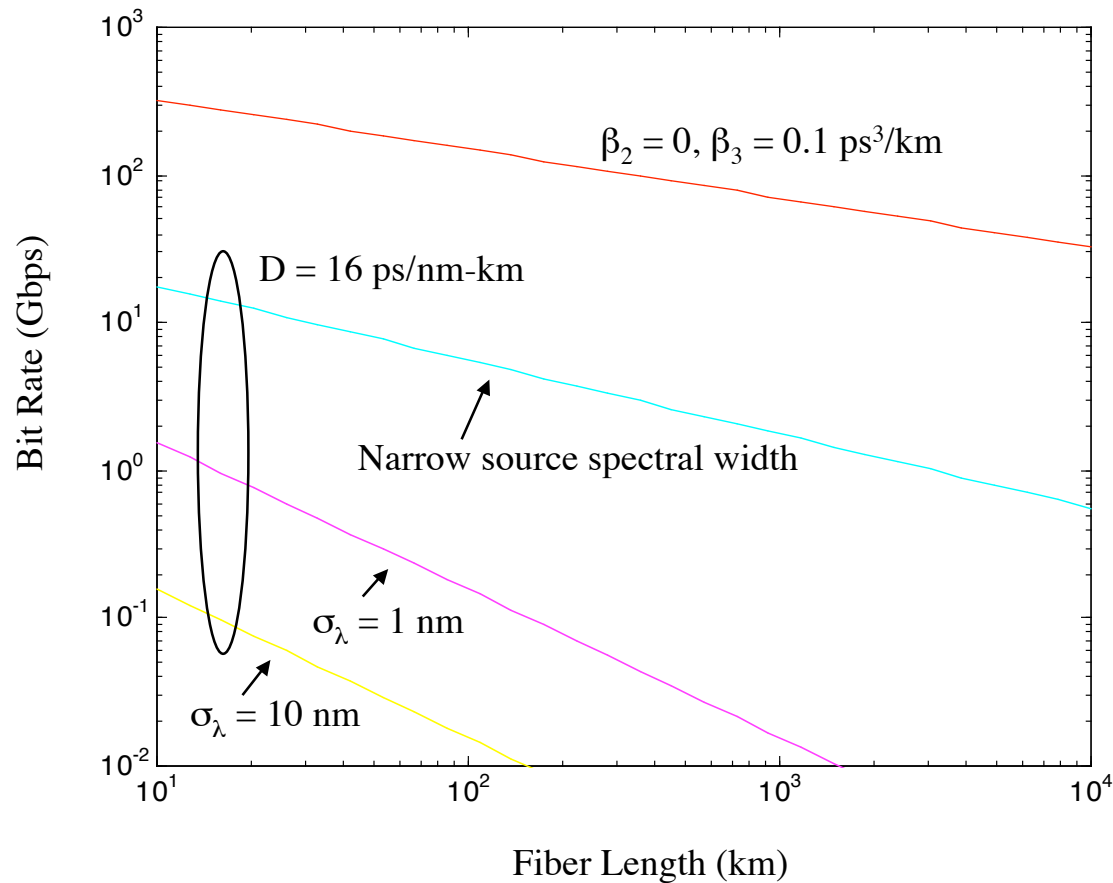

For standard SMF fibers, the limit at 10 Gbit/ is of the order of 100 km (400 km at 2.5 Gb/s)

Note that the limit at the zero dispersion points are extremely high. Unfortunately they cannot be reached due to other effects (fiber nonlinearity)

Polarization Mode Dispersion (PMD)

- ⇒ An input optical pulse is randomly coupled, along the fiber, with the two local orthogonal states of polarization
- ⇒ The two states has slightly different group velocities
Related to PMD delay
- ⇒ This effect is called PMD

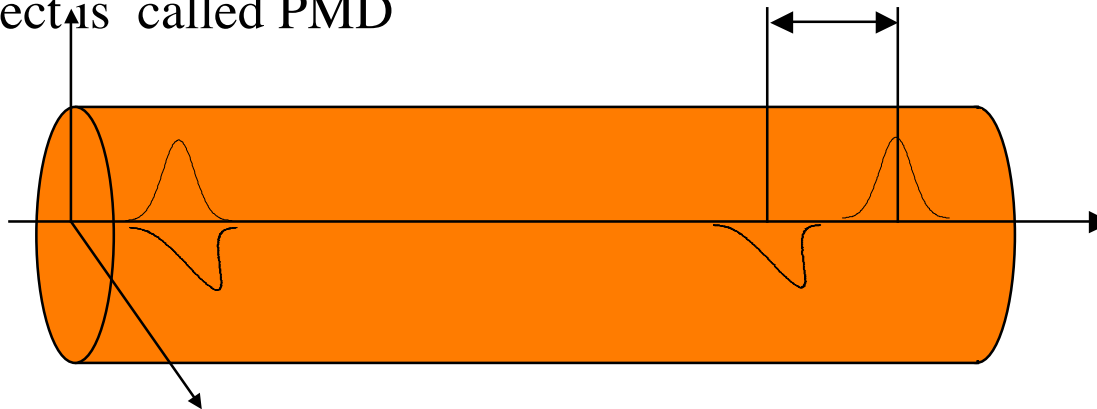

- ⇒ PMD will broaden pulses in the same way other dispersion mechanisms do
- ⇒ PMD changes instantly along fiber as a function of time, temperature and wavelength
- ⇒ Power penalties associated with PMD are time varying

PMD limit

- ⇒ A (quite approximated) formula that shows the PMD limit is the following (see Optical Fiber Communications IIIa, I. Kaminov, T. Koch, Academic Press)

$$B^2 L \approx \frac{0.02}{PMD^2} \Rightarrow L_{\max} = \frac{0.02}{PMD^2 \cdot B^2}$$

	Bit rate = 10 Gbit/s	Bit rate = 40 Gbit/s
PMD=0.1 $ps/km^{0.5}$	$L_{\max}=20.000$ Km	$L_{\max}=1250$ Km
PMD=1 $ps/km^{0.5}$	$L_{\max}=200$ Km	$L_{\max}=12.5$ Km

- ⇒ New fibers have PMD values of the order of 0.1 $ps/km^{0.5}$
- ⇒ PMD is an issue on ultra long distance only
- ⇒ Installed fiber often have PMD values close to 1 $ps/km^{0.5}$
- ⇒ In these cases, PMD may be a fundamental issue even at 10 Gbit/s

Dispersion Compensation Motivation

- ⇒ Optical amplifiers have removed optical loss as the primary limitation. Transmission system bit rates are now “Dispersion Limited”
- ⇒ Operating at the zero dispersion wavelength is good for single channel but makes nonlinearities a primary limitation for WDM
- ⇒ Dispersion accumulates over multiple fiber/amplifier spans
- ⇒ Fiber nonlinear effects decreases when increasing the value of the dispersion parameter D
- ⇒ The solution: find a way to have
 - ⇒ high local dispersion along the link, to reduce nonlinear effect
 - ⇒ Reduced dispersion effects
 - ⇒ Approaches
 - ⇒ Pre-chirp
 - ⇒ Post compensation
 - ⇒ Dispersion management

Dispersion Pre-Compensation

⇒ **Pre-Chirping and Pulse Shaping:** Pre-distort the pulse so that dispersion produces a close to ideal pulse at the output of a fiber of length L with dispersion β_2 . For example, prechirping the laser with parameter $+C$ in a fiber with dispersion $-\beta_2$.

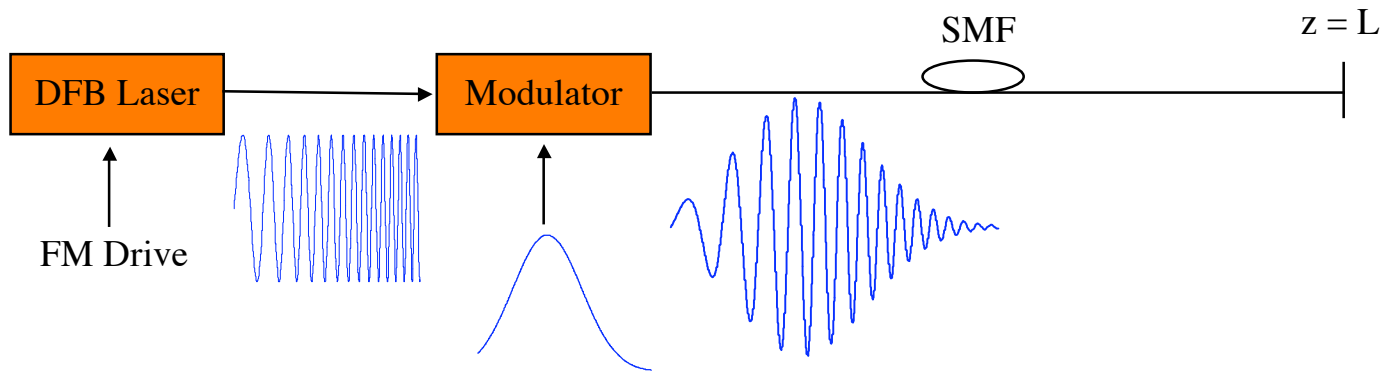

$$L = \frac{C + \sqrt{1 + 2C^2}}{1 + C^2} \frac{T_0^2}{|\beta_2|}, \text{ for } \frac{T(L)}{T_0} = \sqrt{2} \quad \dagger$$

† G. P. Agrawal, Fiber Optic Communications Systems, Wiley-Interscience

Dispersion Pre-Compensation

⇒ **Optical Amplifier Induced Chirp:** The sign of chirp induced by directly modulating a semiconductor laser is opposite in sign to the chirp induced by a semiconductor optical amplifier on an input optical bit when operated in gain saturation.

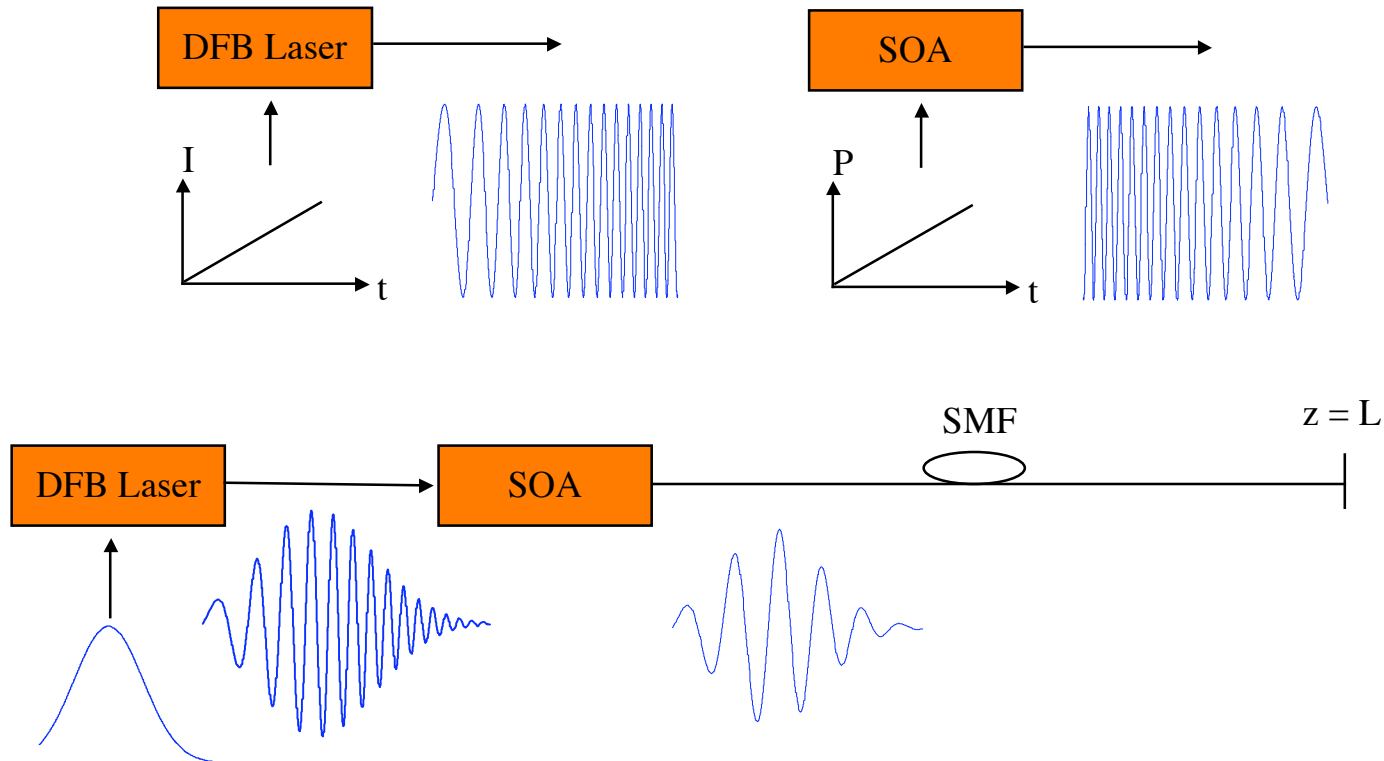

Mid-Span Compensation

- ⇒ Dispersion Management. Basic idea:
 - ⇒ Alternating lengths of fiber with opposite dispersion sign with net zero dispersion at end of link.
- ⇒ This was the initial approach, developed 5-6 years ago

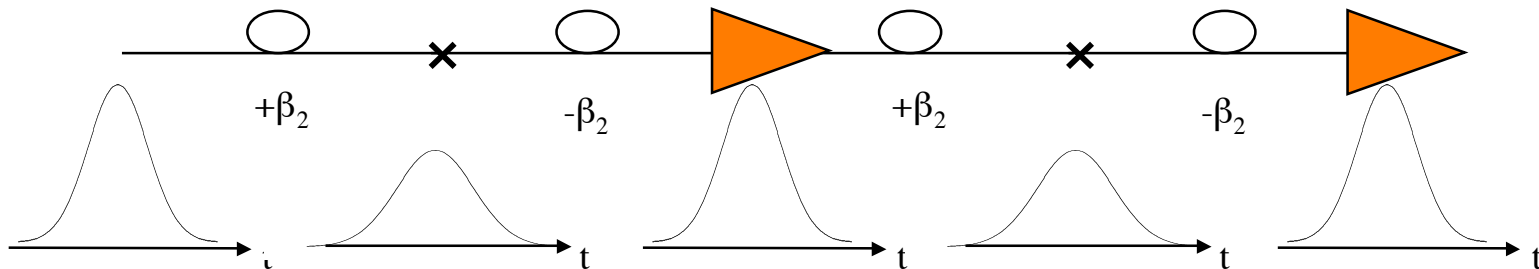

- ⇒ It was then realized that much better results in terms of nonlinearity reduction can be achieved by properly designed dispersion maps

Mid-Span Compensation

⇒ Phase Conjugation via Four-Wave Mixing (FWM)

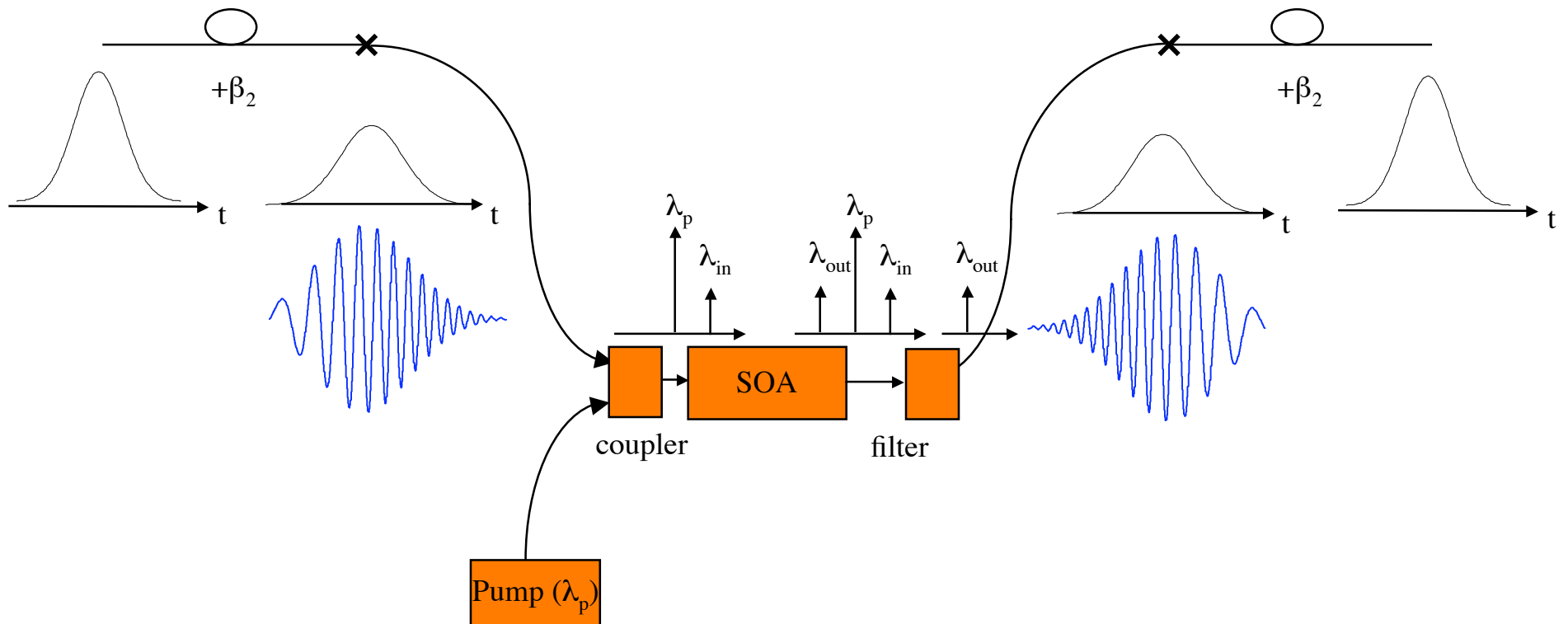

Post Compensation

⇒ Dispersion is compensated at the end of the link, usually with a concentrated optical device, such as a suitable Bragg grating

- ⇒ High Dispersion Fibers
- ⇒ Optical Filters
- ⇒ Fiber Bragg Gratings

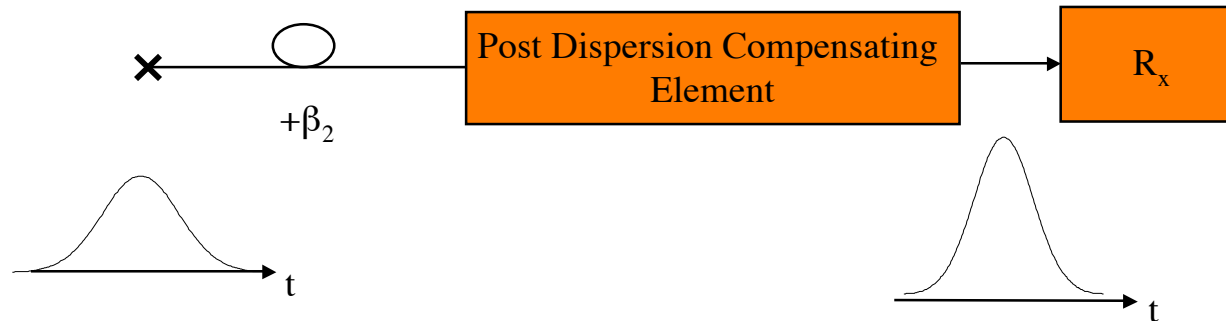

Dispersion management

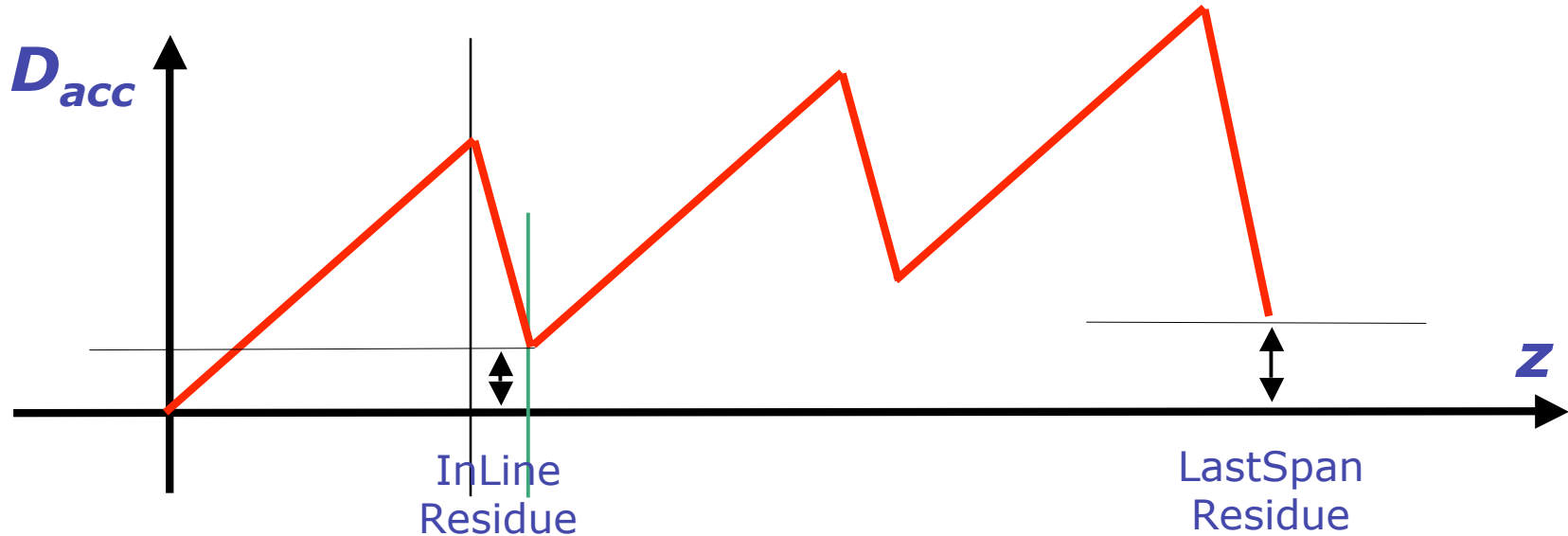

- ⇒ Optimal dispersion maps are extremely difficult to be studied
- ⇒ The optimization is usually performed by a mix of simulation and experiments

Dispersion maps

- ⇒ Optimization of the dispersion map of a 400 km long terrestrial systems
- ⇒ Results obtained using the commercial simulator OptSim

<http://www.artis.it/products/home.html>

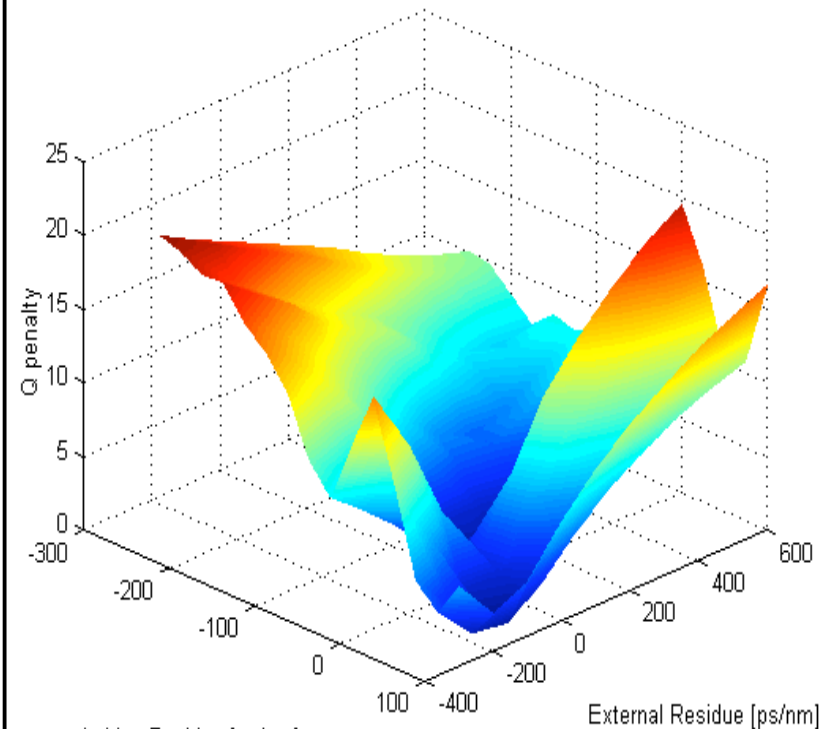
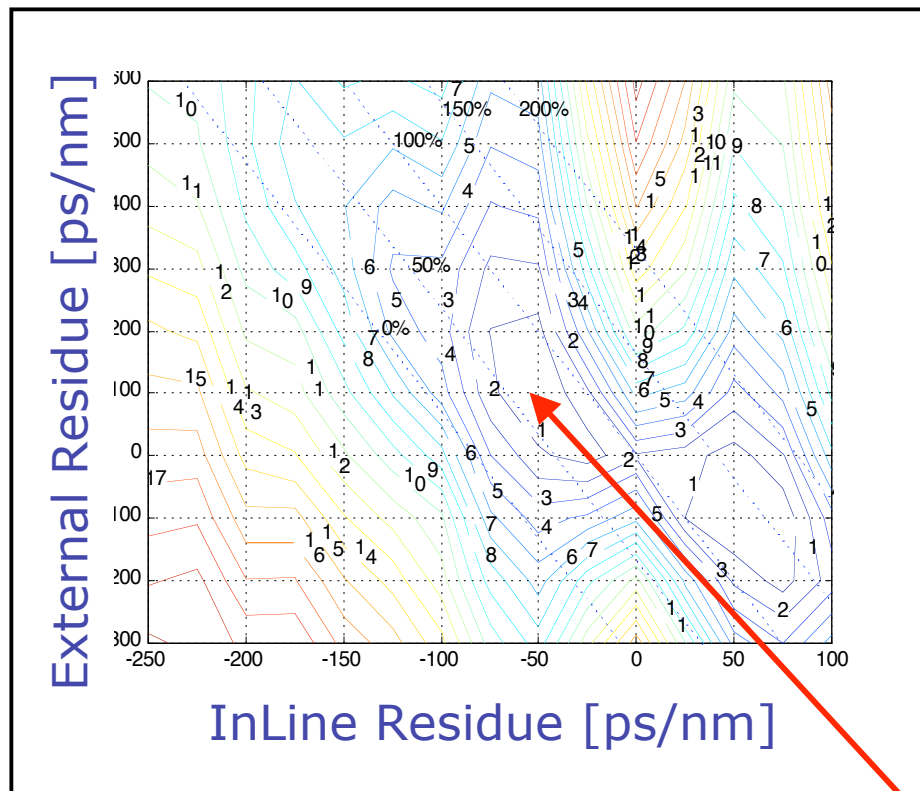

Optimal dispersion region

Dispersion Maps and Optical Networks



- ⇒ Optimal dispersion map design yields closer to the ultimate fiber capacity of point-to-point systems
 - ⇒ All transmission records uses (among other techniques) a careful choice of dispersion map
- ⇒ In a reconfigurable all-optical networks, signals may follow different path, with different power levels
 - ⇒ Dispersion optimization is even more complex
 - ⇒ Several approaches are currently being studied
- ⇒ Several research groups have studied electrical or optical adaptive receivers
 - ⇒ Same technique as in electronic adaptive equalizing filters

Broadband Dispersion Compensation

- ⇒ Since dispersion is wavelength dependent ($\beta_2(\lambda)$), compensation at one WDM channel may not be adequate at another channel
- ⇒ Can use parallel bank of dispersion compensators (one for each channel)
- ⇒ Can design a single broadband compensator

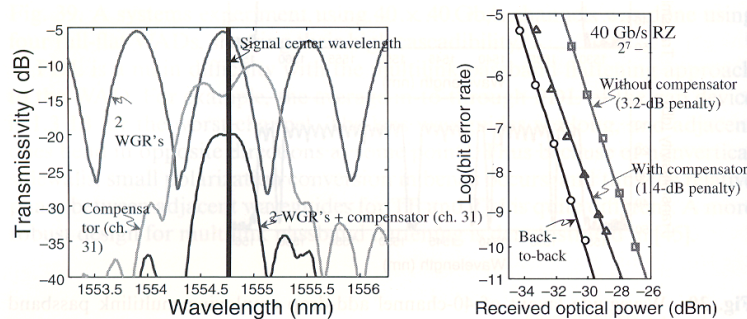
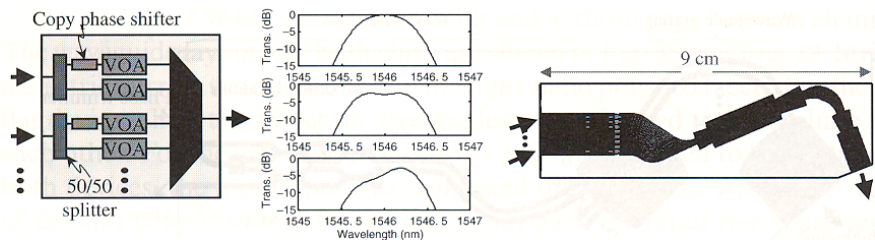

From Kaminow, page 452

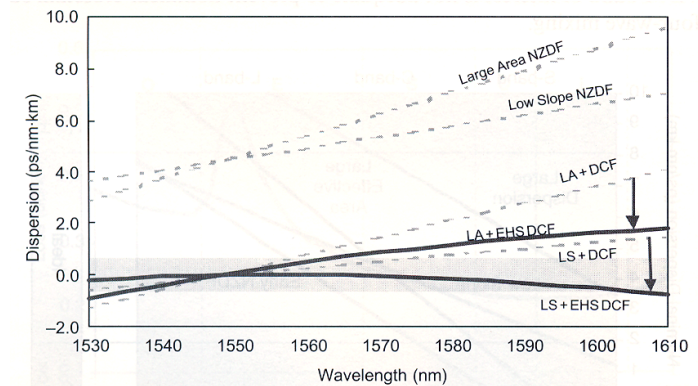

From Kaminow, page 24