

An Introduction to the Sampling Theorem

National Semiconductor
Application Note 236
January 1980



An Introduction to the Sampling Theorem

With rapid advancement in data acquisition technology (i.e. analog-to-digital and digital-to-analog converters) and the explosive introduction of micro-computers, selected complex linear and nonlinear functions currently implemented with analog circuitry are being alternately implemented with sample data systems.

Though more costly than their analog counterpart, these sampled data systems feature programmability. Additionally, many of the algorithms employed are a result of developments made in the area of signal processing and are in some cases capable of functions unrealizable by current analog techniques.

With increased usage a proportional demand has evolved to understand the theoretical basis required in interfacing these sampled data-systems to the analog world.

This article attempts to address the demand by presenting the concepts of aliasing and the sampling theorem in a manner, hopefully, easily understood by those making their first attempt at signal processing. Additionally discussed are some of the unobvious hardware effects that one might encounter when applying the sampled theorem.

With this . . . let us begin.

I. An Intuitive Development

The sampling theorem by C.E. Shannon in 1949 places restrictions on the frequency content of the time function signal, $f(t)$, and can be simply stated as follows:

In order to recover the signal function $f(t)$ exactly, it is necessary to sample $f(t)$ at a rate greater than twice its highest frequency component.

Practically speaking for example, to sample an analog signal having a maximum frequency of 2Kc requires sampling at greater than 4Kc to preserve and recover the waveform exactly.

The consequences of sampling a signal at a rate below its highest frequency component results in a phenomenon known as *aliasing*. This concept results in a frequency mistakenly taking on the identity of an entirely different frequency when recovered. In an attempt to clarify this, envision the ideal sampler of *Figure 1(a)*, with a sample period of T shown in (b), sampling the waveform $f(t)$ as pictured in (c). The sampled data points of $f'(t)$ are shown in (d) and can be defined as the sample set of the continuous function $f(t)$. Note in *Figure 1(e)* that another frequency component, $a'(t)$, can be found that has the same sample set of data points as $f'(t)$ in (d). Because of this it is difficult to determine which frequency $a'(t)$, is truly being observed. This effect is similar to that observed in western movies when watching the

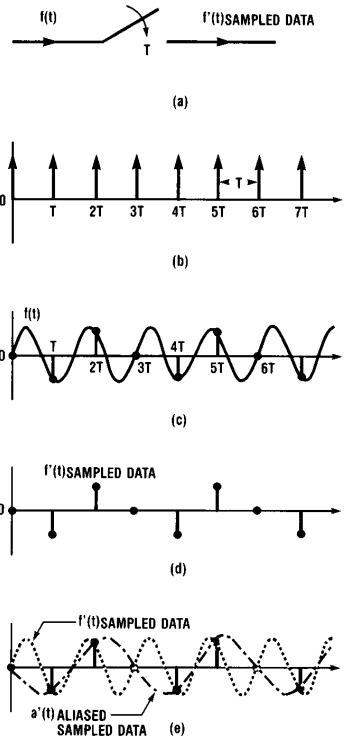

TL/H/5620-1

FIGURE 1. When sampling, many signals may be found to have the same set of data points. These are called aliases of each other.

spoked wheels of a rapidly moving stagecoach rotate backwards at a slow rate. The effect is a result of each individual frame of film resembling a discrete strobed sampling operation flashing at a rate slightly faster than that of the rotating wheel. Each observed sample point or frame catches the spoked wheel slightly displaced from its previous position giving the effective appearance of a wheel rotating backwards. Again, aliasing is evidenced and in this example it becomes difficult to determine which is the true rotational frequency being observed.

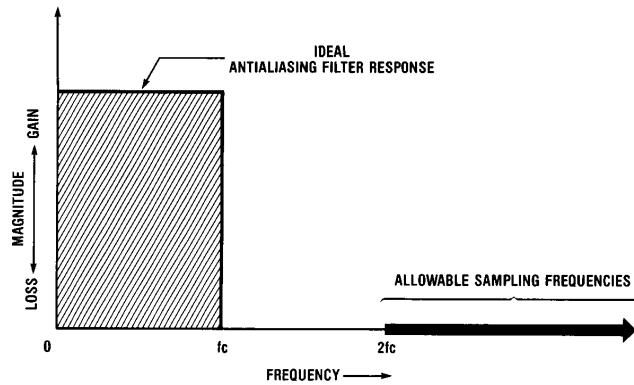

TL/H/5620-2

FIGURE 2. Shown in the shaded area is an ideal, low pass, anti-aliasing filter response. Signals passed through the filter are bandlimited to frequencies no greater than the cutoff frequency, f_c . In accordance with the sampling theorem, to recover the bandlimited signal exactly the sampling rate must be chosen to be greater than $2f_c$.

On the surface it is easily said that anti-aliasing designs can be achieved by sampling at a rate greater than twice the maximum frequency found within the signal to be sampled. In the real world, however, most signals contain the entire spectrum of frequency components; from the desired to those present in white noise. To recover such information accurately the system would require an unrealizably high sample rate.

This difficulty can be easily overcome by preconditioning the input signal, the means of which would be a band-limiting or frequency filtering function performed prior to the sample data input. The prefilter, typically called anti-aliasing filter guarantees, for example in the low pass filter case, that the sampled data system receives analog signals having a spectral content no greater than those frequencies allowed by the filter. As illustrated in *Figure 2*, it thus becomes a simple matter to sample at greater than twice the maximum frequency content of a given signal.

A parallel analog of band-limiting can be made to the world of perception when considering the spectrum of white light. It can be realized that the study of violet light wavelengths generated from a white light source would be vastly simplified if initial band-limiting were performed through the use of a prism or white light filter.

II. The Sampling Theorem

To solidify some of the intuitive thoughts presented in the previous section, the sampling theorem will be presented applying the rigor of mathematics supported by an illustrative proof. This should hopefully leave the reader with a comfortable understanding of the sampling theorem.

Theorem: If the Fourier transform $F(\omega)$ of a signal function $f(t)$ is zero for all frequencies above $|\omega| \geq \omega_c$, then $f(t)$ can be uniquely determined from its sampled values

$$f_n = f(nT) \quad (1)$$

These values are a sequence of equidistant sample points spaced $\frac{1}{2f_c} = \frac{T_c}{2} = T$ apart. $f(t)$ is thus given by

$$f(t) = \sum_{n=-\infty}^{\infty} f(nT) \frac{\sin \omega_c (t - nT)}{\omega_c (t - nT)} \quad (2)$$

Proof: Using the inverse Fourier transform formula:

$$f(t) = \frac{1}{2\pi} \int_{-\infty}^{\infty} F(\omega) \epsilon^{j\omega t} d\omega \quad (3)$$

the band limited function, $f(t)$, takes the form, *Figure 3a*,

$$f(t) = \frac{1}{2\pi} \int_{-\omega_c}^{\omega_c} F(\omega) \epsilon^{j\omega t} d\omega \quad (4)$$

$f_n = f\left(n \frac{\pi}{\omega_c}\right)$ is then given as

$$f_n = \frac{1}{2\pi} \int_{-\omega_c}^{\omega_c} F(\omega) \epsilon^{j\omega \frac{n\pi}{\omega_c}} d\omega \quad (5)$$

See *Figure 3c* and *e*.

Expressing $F(\omega)$ as a Fourier series in the interval $-\omega_c \leq \omega \leq \omega_c$ we have

$$F(\omega) = \sum_{n=-\infty}^{\infty} C_n \epsilon^{-j\omega \frac{n\pi}{\omega_c}} \quad (6)$$

Where,

$$C_n = \frac{1}{2\omega_c} \int_{-\omega_c}^{\omega_c} F(\omega) \epsilon^{j\omega \frac{n\pi}{\omega_c}} d\omega \quad (7)$$

Further manipulating eq. (7)

$$C_n = \frac{2\pi}{2\omega_c 2\pi} \int_{-\omega_c}^{\omega_c} F(\omega) \epsilon^{j\omega \frac{n\pi}{\omega_c}} d\omega \quad (8)$$

C_n can be written as

$$C_n = \frac{\pi}{\omega_c} f_n \quad (9)$$

Substituting eq. (9) into eq. (6) gives the periodic Fourier Transform

$$F_P(\omega) = \sum_{n=-\infty}^{\infty} \frac{\pi}{\omega_c} f_n \epsilon^{-j\omega \frac{n\pi}{\omega_c}} \quad (10)$$

of Figure 3f. Using Poisson's sum formula¹ $F(\omega)$ can be stated more clearly as

$$F(\omega) = \sum_{n=-\infty}^{\infty} F(\omega - 2n\omega_c) \quad (11)$$

Interestingly for the interval $-\omega_c \leq \omega \leq \omega_c$ the periodic function $F_P(\omega)$ and Figure 3f. equals $F(\omega)$ and Figure 3b. respectively. Analogously if $F_P(\omega)$ were multiplied by a rectangular pulse defined,

$$H(\omega) = 1 \quad -\omega_c \leq \omega \leq \omega_c \quad (12)$$

and

$$H(\omega) = 0 \quad |\omega| \geq \omega_c \quad (13)$$

then as pictured in Figures 4b, d, and f,

$$F(\omega) = H(\omega) \bullet F_P(\omega) = H(\omega) \sum_{n=-\infty}^{\infty} \frac{\pi}{\omega_c} f_n \epsilon^{-j\omega \frac{n\pi}{\omega_c}} \quad (14)$$

Solving for $f(t)$ the inverse Fourier transform eq (3) is applied to eq (14)

$$\begin{aligned} f(t) &= \frac{1}{2\pi} \int_{-\omega_c}^{\omega_c} F(\omega) \epsilon^{j\omega t} d\omega \quad (3) \\ &= \frac{1}{2\pi} \int_{-\omega_c}^{\omega_c} \left[H(\omega) \sum_{n=-\infty}^{\infty} \frac{\pi}{\omega_c} f_n \epsilon^{-j\omega \frac{n\pi}{\omega_c}} \right] \epsilon^{j\omega t} d\omega \\ &= \sum_{n=-\infty}^{\infty} f_n \frac{1}{2\omega_c} \int_{-\omega_c}^{\omega_c} \epsilon^{j\omega \left(t - \frac{n\pi}{\omega_c} \right)} d\omega \end{aligned}$$

¹Poisson's sum formula

$$\frac{1}{T} \sum_{n=-\infty}^{\infty} F(\omega - n\omega_s) = \sum_{n=-\infty}^{\infty} f(nT) \epsilon^{-j\omega nT}$$

where $T = \frac{1}{f_s}$ and f_s is the sampling frequency

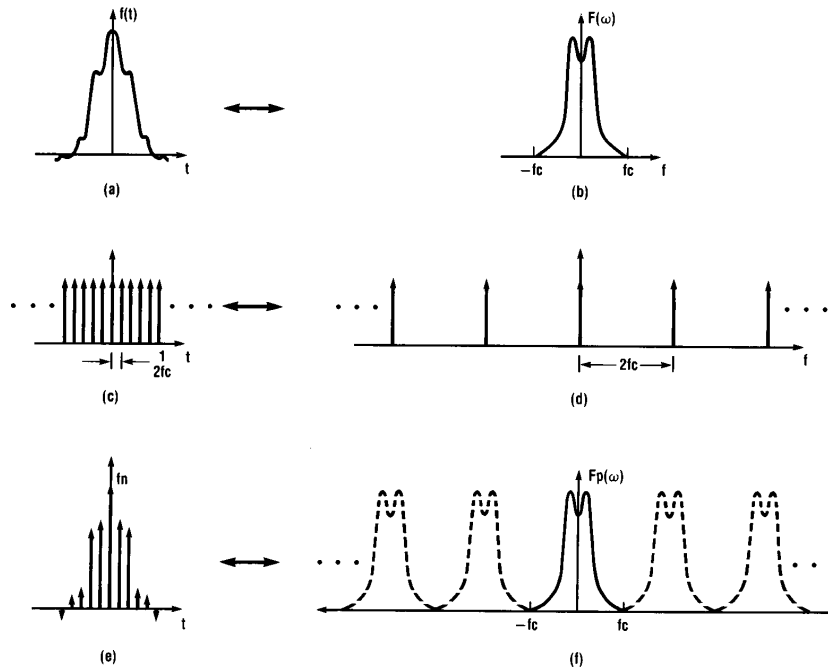
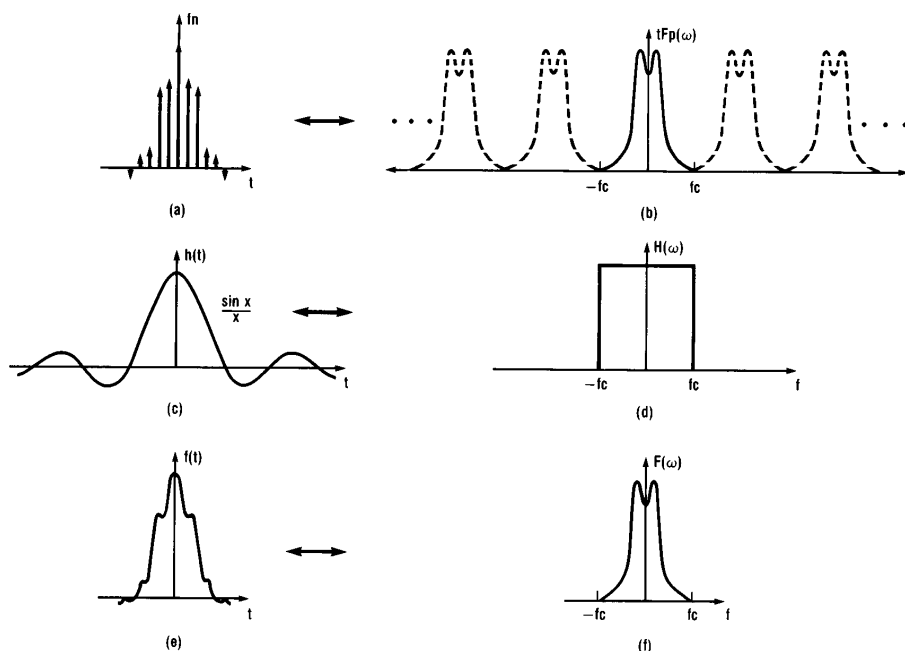

FIGURE 3. Fourier transform of a sampled signal.

TL/H/5620-3



TL/H/5620-4

FIGURE 4. Recovery of a signal $f(t)$ from sampled data information.

giving

$$f(t) = \sum_{n=-\infty}^{\infty} f_n \frac{\sin \omega_c \left(t - \frac{n\pi}{\omega_c} \right)}{\omega_c \left(t - \frac{n\pi}{\omega_c} \right)} \quad (15)$$

Eq (15) is equivalent to eq (2) as is illustrated in Figure 4e and Figure 3a respectively.

As observed in Figures 3 and 4, each step of the sampling theorem proof was also illustrated with its Fourier transform pair. This was done to present alternate illustrative proofs.

Recalling the convolution² theorem, the convolution of $F(\omega)$, Figure 3b, with a set of equidistant impulses, Figure 3d, yields the same periodic frequency function $F_p(\omega)$, Figure 3f, as did the Fourier transform of f_n , Figure 3e, the product of $f(t)$, Figure 3a, and its equidistant sample impulses, Figure 3c.

In the same light the original time function $f(t)$, Figure 4e, could have been recovered from its sampled waveform by convolving f_n , Figure 4a, with $h(t)$, Figure 4c, rather than multiplying $F_p(\omega)$, Figure 4b, by the rectangular function $H(\omega)$, Figure 4d, to get $F(\omega)$, Figure 4f, and finally inverse transforming to achieve $f(t)$, Figure 4e, as done in the mathematic proof.

III. Some Observations and Definitions

If Figures 3f or 4b are re-examined it can be noted that the original spectrum $F_p(\omega)$, $|\omega| \leq \omega_c$, and its images $F_p(\omega)$,

$|\omega| \geq \omega_c$, are non-overlapping. On the other hand Figure 5 illustrates spectral folding, overlapping or aliasing of the spectrum images into the original signal spectrum. This aliasing effect is, in fact, a result of undersampling and further causes the information of the original signal to be indistinguishable from its images (i.e. Figure 1e). From Figure 6 one can readily see that the signal is thus considered non-recoverable.

The frequency $|f_c|$ of Figure 3f and 4b is exactly one half the sampling frequency, $f_c = f_s/2$, and is defined as the Nyquist frequency (after Harry Nyquist of Bell Laboratories). It is also often called the aliasing frequency or folding frequency for the reasons discussed above. From this we can say that in order to prevent aliasing in a sampled-data system the sampling frequency should be chosen to be greater than twice the highest frequency component f_c of the signal being sampled.

By definition

$$f_s \geq 2f_c \quad (16)$$

Note, however, that no mention has been made to sample at precisely the Nyquist rate since in actual practice it is

² The convolution theorem allows one to mathematically convolve in the time domain by simply multiplying in the frequency domain. That is, if $f(t)$ has the Fourier transform $F(\omega)$, and $x(t)$ has the Fourier transform $X(\omega)$, then the convolution $f(t) * x(t)$ has the Fourier transform $F(\omega) * X(\omega)$.

$$f(t) * x(t) \longleftrightarrow F(\omega) * X(\omega)$$

$$f(t) \bullet x(t) \longleftrightarrow F(\omega) \bullet X(\omega)$$

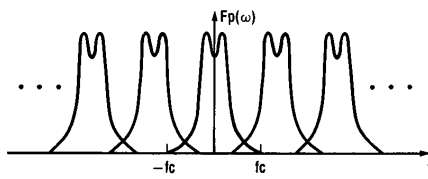

(a)

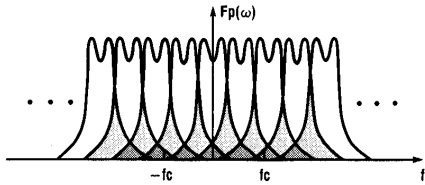

(b)

TL/H/5620-5

FIGURE 5. Spectral folding or aliasing caused by:
(a) under sampling
(b) exaggerated under sampling.

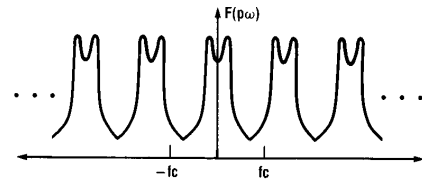

(a)

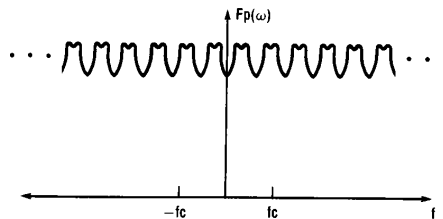

(b)

TL/H/5620-6

FIGURE 6. Aliased spectral envelope (a) and (b) of Figures 5a and 5b respectively.

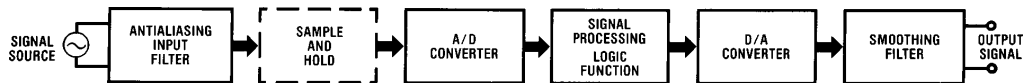

TL/H/5620-7

FIGURE 7. Generalized single channel sample data system.

impossible to sample at $f_s = 2f_c$ unless one can guarantee there are absolutely no signal components above f_c . This can only be achieved by filtering the signal prior to sampling with a filter having infinite rolloff . . . a physical impossibility, see *Figure 2*.

IV. The Sampling Theorem and Its Hardware Implications

Though there are numerous sophisticated techniques of implementation, it is appropriate to re-emphasize that the intent of this article is to give the first time user a basic and fundamental approach toward the design of a sampled-data system. The method with which to achieve this goal will be to introduce a few of the common perils encountered when implementing such a system. We begin by considering the generalized block diagram of *Figure 7*.

As shown in *Figure 7*, prior to any signal processing manipulation the analog input signal must be preconditioned to prevent aliasing and thereafter digitized to logic signals usable by the logic function block. The antialiasing and digitizing functions are performed by an input filter and analog-to-digital converter respectively. Once digitized the signal can then be altered or processed and upon completion, reconstructed back to a continuous analog signal via a digital-to-analog converter followed by a smoothing filter.

To this point no mention has been made concerning the sample and hold circuit block depicted in *Figure 7*. In general the analog-to-digital converter can operate as a stand alone unit. In many high speed operations however, the converter speed is insufficient and thus requires the assistance of a sample and hold circuit. This will be discussed in detail further in the article.

A. The Antialiasing Input Filter

As indicated earlier in the text, the antialiasing filter should band-limit the input signal's spectrum to frequencies no greater than the Nyquist frequency. In the real world however, filters are non-ideal and have typical attenuation or band-limiting and phase characteristics as shown in *Figure 8*.³ It must also be realized that true band-limiting of a specific frequency spectrum is not possible. In the sample data system band-limiting is achieved by attenuating those frequencies greater than the Nyquist frequency to a level undetectable or invisible to the system analog-to-digital (A/D) converter. This level would typically be less than the rms quantization⁴ noise level defined by the specific converter being used.

³In order not to disrupt the flow of the discussion a list of filter terms has been presented in Appendix A.

⁴For an explanation of quantization refer to section IV. B. of this article.

As an example of how an antialiasing filter would be applied, assume a sample data system having within it an 8-bit A/D converter. Eight bits translates to $2^n = 2^8 = 256$ levels of resolution. If a 2.56 volt reference were used each quantization level, q , would represent the equivalent of 2.56 volts/256 = 10 millivolts. Realizing this the antialiasing filter would be designed such that frequencies in the stopband were attenuated to less than the rms quantization noise level of $q/2\sqrt{3}$ and thus appearing invisible to the system. More specifically

$$-20 \log_{10} \frac{V \text{ full scale}}{V_{q/2\sqrt{3}}} \cong -59 \text{ dB} = A_{\text{MIN}}$$

It can be seen, for example in the Butterworth filter case (characterized as having a maximally flat pass-band) of *Figure 9a* that any order of filter may be used to achieve the -59 dB attenuation level, however, the higher the order, the faster the roll off rate and the closer the filter magnitude response will approach the ideal.

Referring back to *Figure 8* it is observed that those frequencies greater than ω_a are not recognized by the A/D converter and thus the sampling frequency of the sample data system would be defined as $\omega_s \geq 2\omega_a$. Additionally, the frequencies present within the filtered input signal would be those less than ω_a . Note however, that the portion of the signal frequencies least distorted are those between $\omega = 0$ and ω_p and those within the transition band are distorted to a substantial degree, though it was originally desired to limit the signal to frequencies less than the cutoff ω_p , because of the non-ideal frequency response the true Nyquist frequency occurred at ω_a . We see then that the sampled-data system could at most be accurate for those frequencies within the antialiasing filter passband.

From the above example, the design of an antialiasing filter appears to be quite straight forward. Recall however, that all waveforms are composed of the sums and differences of various frequency components and as a result, if the response of the filter passband were not flat for the desired signal frequency spectrum, the recovered signal would be an inaccurate summation of all frequency components altered by their relative attenuations in the pass-band.

Additionally the antialiasing filter design should not neglect the effects of delay. As illustrated in *Figure 8* and *9b*, delay time corresponds to a specific phase shift at a particular

frequency. Similar to the flat pass-band consideration, if the phase shift of the filter is not exactly proportional to the frequency, the output of the filter will be a waveform in which the summation of all frequency components has been altered by shifts in their relative phase. *Figure 9b* further indicates that contrary to the roll off rate, the higher the filter order the more non-ideal the delay becomes (increased delay) and the result is a distorted output signal.

A final and complex consideration to understand is the effects of sampling. When a signal is sampled the end effect is the multiplication of the signal by a unit sampling pulse train as recalled from *Figure 3a, c* and *e*. The resultant waveform has a spectrum that is the convolution of the signal spectrum and the spectrum of the unit sample pulse train, i.e. *Figure 3b, d*, and *f*. If the unit sample pulse has the classical $\text{sin } X/X$ spectrum⁵ of a rectangular pulse, see *Figure 13*, then the convolution of the pulse spectrum with the signal spectrum would produce the non-ideal sampled signal spectrum shown in *Figure 10a, b*, and *c*.

It should be realized that because of the band-limiting or filtering and delay response of the $\text{Sin } X/X$ function combined with the effects of the non-ideal antialiasing filter (i.e. non-flat pass-band and phase shift) certain of the sum and difference frequency components may fall within the desired signal spectrum thereby creating aliasing errors, *Figure 10c*.

When designing antialiasing filters it will be found that the closer the filter response approaches the ideal the more complex the filter becomes. Along with this an increase in delay and pass-band ripple combine to distort and alias the input signal. In the final analysis the design will involve trade offs made between filter complexity, sampling speed and thus system bandwidth.

B. The Analog-to-Digital Converter

Following the antialiasing filter is the A/D converter which performs the operations of quantizing and coding the input signal in some finite amount of time. *Figure 11* shows the quantization process of converting a continuous analog input signal into a set of discrete output levels. A quantization, q , is thus defined as the smallest step used in the digital

⁵This will be explained more clearly in Section IV. of this article.

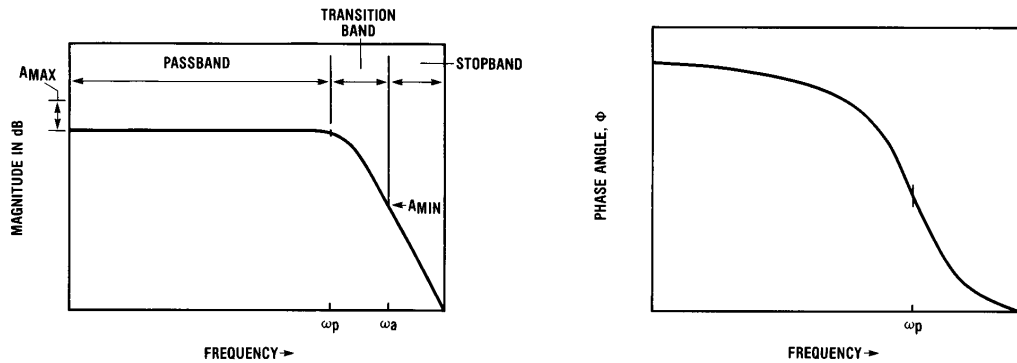
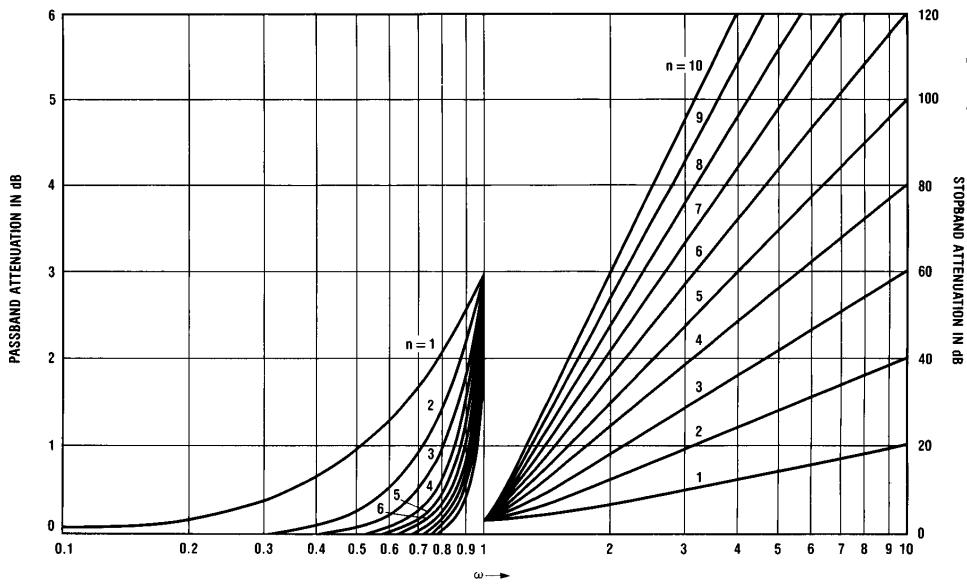

FIGURE 8. Typical filter magnitude and phase versus frequency response.

TL/H/5620-8



TL/H/5620-9

a) Attenuation characteristics of a normalized Butterworth filter as a function of degree n .

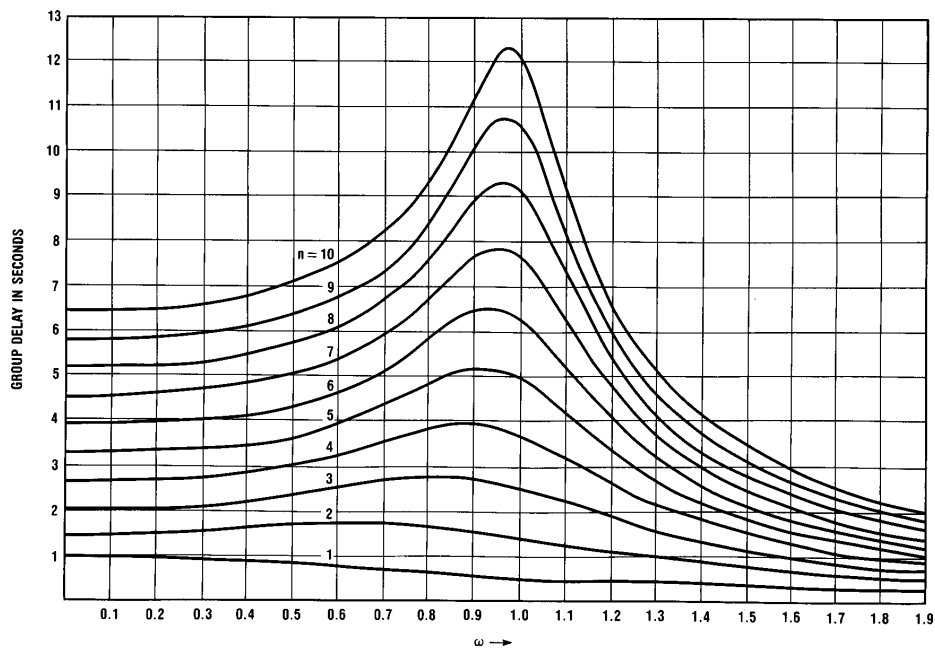

TL/H/5620-10

b) Group delay performances of normalized Butterworth lowpass filters as a function of degree n .

FIGURE 9

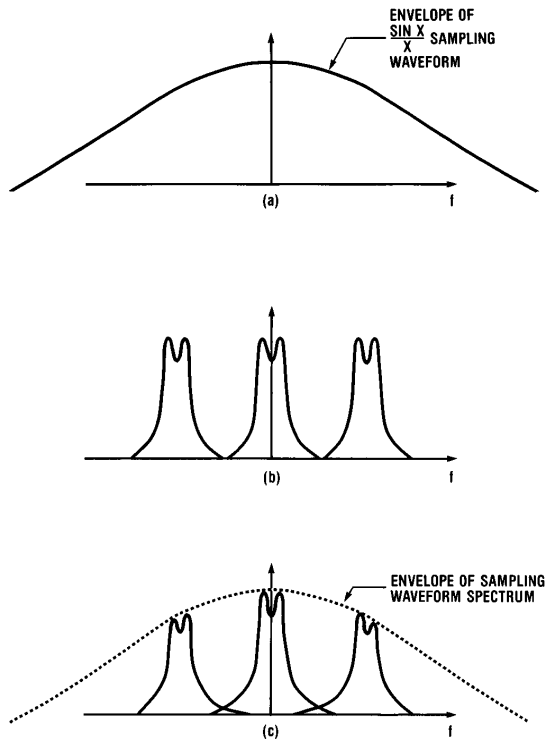

FIGURE 10. (c) equals the convolution of (a) with (b).

TL/H/5620-11

representation of $f_q(n)$ where $f(n)$ is the sample set of an input signal $f(t)$ and is expressed by a finite number of bits giving the sequence $f_q(n)$. Digitally speaking q is the value of the least significant code bit. The difference signal $\epsilon(n)$ shown in Figure 11 is called quantization noise or error and can be defined as $\epsilon(n) = f(n) - f_q(n)$. This error is an irreducible one and is a function of the quantizing process. Its error amplitude is dependent on the number of quantization levels or quantizer resolution and as shown, the maximum quantization error is $|q/2|$.

Generally $\epsilon(n)$ is treated as a random error when described in terms of its probability density function, that is, all values of $\epsilon(n)$ between $q/2$ and $-q/2$ are equally probable, then for the average value $\epsilon(n)_{avg} = 0$ and for the rms value $\epsilon(n)_{rms} = q/2\sqrt{3}$.

As a side note it is appropriate at this point to emphasize that all analog signals have some form of noise corruption. If for example an input signal has a finite signal-to-noise ratio of 40dB it would be superfluous to select an A/D converter with a high number of bits. It may be realized that the use of a large number of bits does not give the digitized signal a higher signal-to-noise ratio than that of the original analog input signal. As a supportive argument one may say that though the quantization steps q are very small with respect to the peak input signal the lower order bits of the A/D converter merely provide a more accurate representation of the noise inherent in the analog input signal.

Returning to our discussion, we define the conversion time as the time taken by the A/D converter to convert the analog input signal to its equivalent quantization or digital code. The conversion speed required in any particular application depends upon the time variation of the signal to be converted and the amount of resolution or bits, n , required. Though the antialiasing filter helps to control the input signal time rate of change by band-limiting its frequency spectrum, a finite amount of time is still required to make a measurement or conversion. This time is generally called the aperture time and as illustrated in Figure 12 produces amplitude measurement uncertainty errors. The maximum rate of change detectable by an A/D converter can simply be stated as

$$\left. \frac{dv}{dt} \right|_{\text{maximum resolvable rate of change}} = \frac{V \text{ full scale}}{2^n T_{\text{conversion time}}} \quad (17)$$

If for example V full scale = 10.24 volts, T conversion time = 10 ms, and $n = 10$ or 1024 bits of resolution then the maximum rate of change resolvable by the A/D converter would be 1 volt/sec. If the input signal has a faster rate of change than 1 volt/sec, 1 LSB changes cannot be resolved within the sampling period.

In many instances a sample-and-hold circuit may be used to reduce the amplitude uncertainty error by measuring the input signal with a smaller aperture time than the conversion time aperture of the A/D converter. In this case the

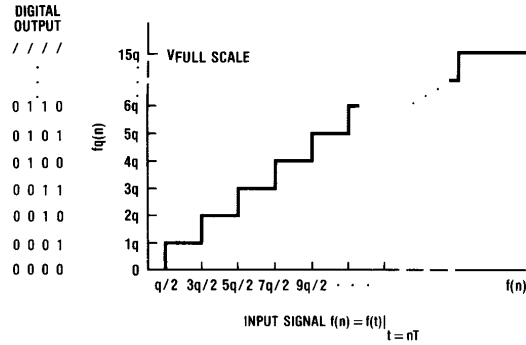
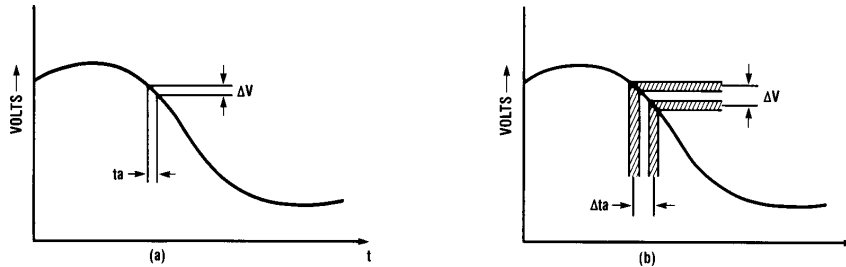

FIGURE 11. Quantization error.

TL/H/5620-12



ΔV: AMPLITUDE UNCERTAINTY ERROR
 ta: APERTURE TIME
 Δta: APERTURE TIME UNCERTAINTY

TL/H/5620-13

FIGURE 12. Amplitude uncertainty as a function of (a) a nonvarying aperture and (b) aperture time uncertainty.

maximum rate of change resolvable by the sample-and-hold would be

$$\left. \frac{dv}{dt} \right|_{\text{maximum resolvable rate of change}} = \frac{V \text{ full scale}}{t \text{ aperture}} \quad (18)$$

Note also that the actual calculated rate of change may be limited by the slew rate specification for the sample-and-hold in the track mode. Additionally it is very important to clarify that this does not imply violating the sampling theorem in lieu of the increased ability to more accurately sample signals having a fast time rate of change.

An ideal sample-and-hold effectively takes a sample in zero time and with perfect accuracy holds the value of the sample indefinitely. This type of sampler is also known as a zero order hold circuit and its effect on a sample data system warrants some discussion.

It is appropriate to recall the earlier discussion that the spectrum of a sampled signal is one in which the resultant spectrum is the product obtain by convolving the input signal spectrum with the $\sin X/X$ spectrum of the sampling waveform. Figure 13 illustrates the frequency spectrum plotted from the Fourier transform

$$F(\omega) = AT \frac{\sin \frac{\omega T}{2}}{\frac{\omega T}{2}} \quad (19)$$

of a rectangular pulse. The $\sin X/X$ form occurs frequently in modern communication theory and is commonly called the sampling function.

The magnitude and phase of a typical zero order hold sampler spectrum

$$H(\omega) = A \left[\tau \frac{\sin \omega \tau}{\omega \tau} + j \frac{1}{\omega} (\cos \omega - 1) \right] \quad (20)$$

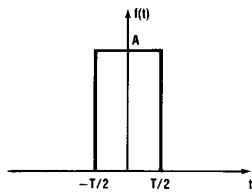

(a)

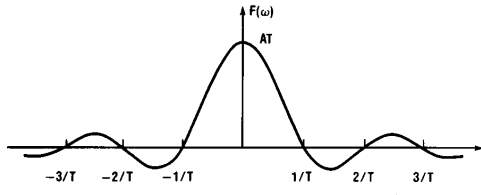

(b)

TL/H/5620-14

FIGURE 13. The Fourier transform of the rectangular pulse (a) is shown in (b).

is shown in *Figure 14* and *Figure 15* illustrates the spectra of various sampler pulse-widths. The purpose of presenting this illustrative information is to give insight at to what effects cause the aliasing described in *Figure 10*. From *Figure 15* it is realized that the main lobe of the $\text{sin } X/X$ function varies inversely proportional with the sampler pulse-width. In other words a wide pulse-width, or in this case the aperture window, acts as a low pass filtering function and

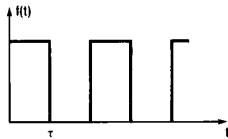

(a)

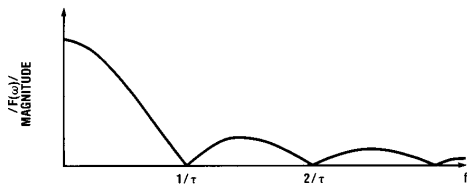

(b)

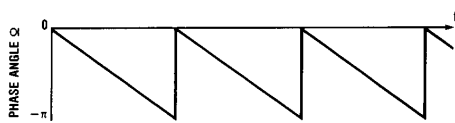

(c)

TL/H/5620-15

FIGURE 14. Sampling Pulse (a), its Magnitude (b) and Phase Response (c).

limits the amount of information resolvable by the sample data system. On the other hand a narrow sampler pulse-width or aperture window has a broader main lobe or bandwidth and thus when convolved with the analog input signal produces the least amount of distortion. Understandably then the effect of the sampler's spectral phase and main lobe width must be considered when developing a sampling system so that no unexpected aliasing occurs from its convolution with the input signal spectrum.

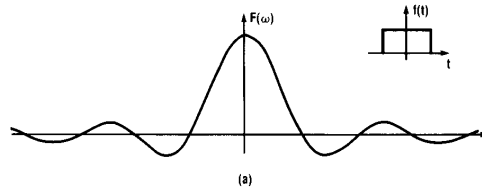

(a)

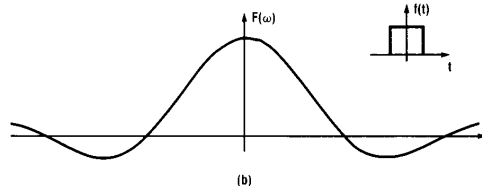

(b)

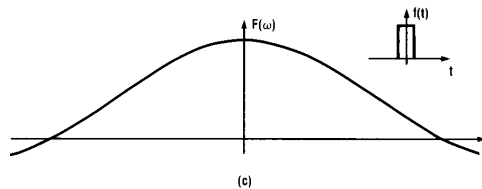

(c)

TL/H/5620-16

FIGURE 15. Pulse width and how it effects the $\text{sin } X/X$ envelop spectrum (normalized amplitudes).

C. The Digital-to-Analog Converter and Smoothing Filter

After a signal has been digitally conditioned by the signal processing unit of *Figure 7*, a D/A converter is used to convert the sampled binary information back in to an analog signal. The conversion is called a zero order hold type where each output sample level is a function of its binary weight value and is held until the next sample arrives, see *Figure 16*. As a result of the D/A converter step function response it is apparent that a large amount of undesirable high frequency energy is present. To eliminate this the D/A converter is usually followed by a smoothing filter, having a cutoff frequency no greater than half the sampling frequency. As its name suggests the filter output produces a smoothed version of the D/A converter output which in fact is a convolved function. More simply said, the spectrum of the resulting signal is the product of a step function $\text{sin } X/X$ spectrum and the band-limited analog filter spectrum. Analogous to the input sampling problem, the smoothed output may have aliasing effects resulting from the phase and attenuation relations of the signal recovery system (defined as the D/A converter and smoothing filter combination).

As a final note, the attenuation due to the D/A converter $\sin X/X$ spectrum shape may in some cases be compensated for in the signal processing unit by pre-processing using a digital filter with an inverse response $X/\sin X$ prior to D/A conversion. This allows an overall flat magnitude signal response to be smoothed by the final filter.

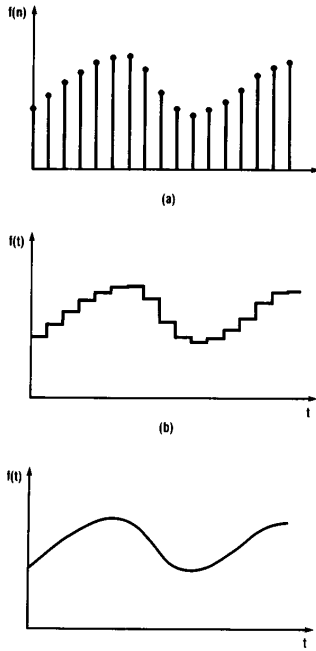

TL/H/5620-17
**FIGURE 16. (a) Processed signal data points
 (b) output of D/A converter
 (c) output of smoothing filter.**

V. A Final Note

This article began by presenting an intuitive development of the sampling theorem supported by a mathematical and illustrative proof. Following the theoretical development were a few of the unobvious and troublesome results that develop when trying to put the sampling theorem into practice. The purpose of presenting these thought provoking perils was to perhaps give the beginning designer some insight or guidelines for consideration when developing a sample data system's interface.

VI. Acknowledgements

The author wishes to thank James Moyer and Barry Siegel for their encouragement and the time they allocated for the writing of this article.

APPENDIX A

Basic Filter Concepts

A filter is a network used for separating signal waves on the basis of their frequency and is usually composed of passive, reactive and active elements such as resistors, capacitors, inductors, and amplifiers, or combinations thereof.

There are basically five types of filters used to pass or reject such signals and they are defined as follows:

1. A low-pass filter passes a band of frequencies called the *passband*, ranging from zero frequency or DC to a certain *cutoff frequency*, ω_c^* , and in addition has a maximum attenuation or ripple level of A_{MAX} within the passband. See Figure 1.

*Recall that the radian frequency $\omega = 2\pi f$.

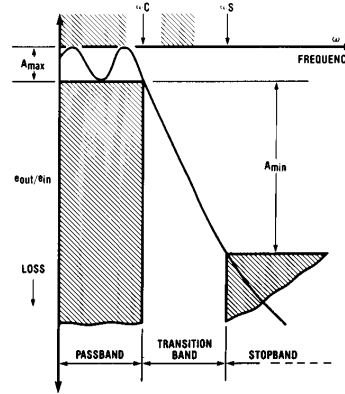

TL/H/5620-18

FIGURE 1. Common Low Pass Filter Response

Frequencies beyond the ω_c may have an attenuation greater than A_{MAX} but beyond a specific frequency ω_s defined as the *stopband frequency*, a minimum attenuation of A_{MIN} must prevail. The band of frequencies higher than ω_s and maintaining attenuation greater than or equal to A_{MIN} is called the *stopband*. The transition region or *transition band* is that band of frequencies between ω_c and ω_s .

2. A high-pass filter allows frequencies above the passband frequency, ω_c , to pass and rejects frequencies below this point. A_{MAX} must be maintained in the passband and frequencies equal to and below the stopband frequency, ω_s , must have a minimum attenuation of A_{MIN} . See Figure 2.

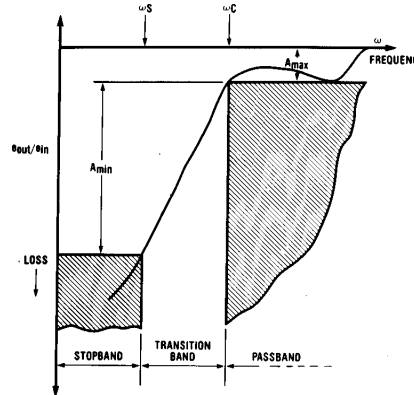

TL/H/5620-19

FIGURE 2. Common High Pass Filter Response

3. A bandpass filter performs the function of passing a specific band of frequencies while rejecting those frequencies above and below ω_{c2} and lower, ω_{c1} cutoff frequency limits. See Figure 3.

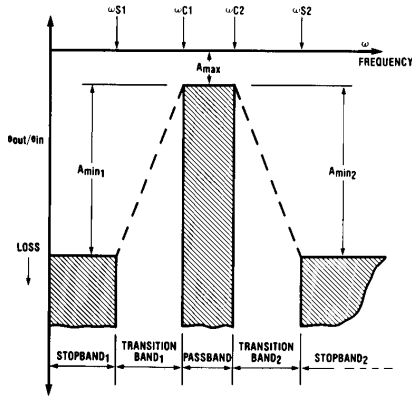

TL/H/5620-20

Figure 3. Common Band-pass Filter Response

As in the previous two cases the passband is required to sustain an attenuation of A_{MAX} , and the stopband of frequencies above and below ω_{s2} and ω_{s1} respectively, must have a minimum attenuation of A_{MIN} .

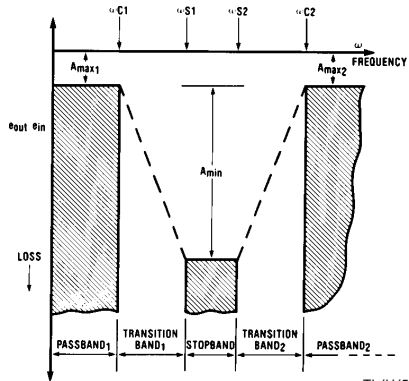

TL/H/5620-21

Figure 4. Common Band-Reject Filter Response

4. A band-reject filter or notch filter allows all but a specific band of frequencies to pass. As shown in Figure 4, those frequencies between ω_{s1} and ω_{s2} are filtered out and those frequencies above and below ω_{c2} and ω_{c1} respectively are passed. The attenuation requirements of the stopband A_{MIN} and passband A_{MAX} must still hold.

5. An all-pass or phase shift filter allows all frequencies to pass without any appreciable attenuation. It further introduces a predictable phase shift to all frequencies passed, though not restricting the entire range of frequencies to a specific phase shift (i.e., a phase shift may be imposed upon a selected band of frequencies and appear invisible to all others).

APPENDIX B

ARTICLE REFERENCES

S.D. Stearns, *Digital Signal Analysis*, Hayden, 1975.
 S.A. Tretter, *Introduction to Discrete-Time Signal Processing*, Wiley, 1976.
 W.D. Stanley, *Digital Signal Processing*, Reston, 1975.
 A. Papoulis, *The Fourier Integral and its Applications*, McGraw-Hill, 1962.
 E.A. Robinson, M. T. Silvia, *Digital Signal Processing and Time Series Analysis*, Holden-Day, 1978.
 C.E. Shannon, "Communication in the Presence of Noise," *Proceedings IRE*, Vol. 37, pp. 10-21, Jan. 1949.
 M. Schwartz, L. Shaw, *Signal Processing: Discrete Spectral Analysis, Detection and Estimation*, McGraw-Hill, 1975.
 L.R. Rabiner, B. Gold, *Theory and Application of Digital Signal Processing*, Prentice-Hall, 1975.
 W.H. Hayt, J.E. Kemmerly, *Engineering Circuit Analysis*, McGraw-Hill, 3rd edition, 1978.
 E.O. Brigham, *The Fast Fourier Transform*, Prentice-Hall, 1974.
 J. Sherwin, *Specifying A/D and D/A converters*, National Semiconductor Corp., Application Note AN-156.
Analog-Digital Conversion Notes, Analog Devices Inc., 1974.
 A.I. Zverev, *Handbook of Filter Synthesis*, Wiley, 1967.

LIFE SUPPORT POLICY

NATIONAL'S PRODUCTS ARE NOT AUTHORIZED FOR USE AS CRITICAL COMPONENTS IN LIFE SUPPORT DEVICES OR SYSTEMS WITHOUT THE EXPRESS WRITTEN APPROVAL OF THE PRESIDENT OF NATIONAL SEMICONDUCTOR CORPORATION. As used herein:

1. Life support devices or systems are devices or systems which, (a) are intended for surgical implant into the body, or (b) support or sustain life, and whose failure to perform, when properly used in accordance with instructions for use provided in the labeling, can be reasonably expected to result in a significant injury to the user.
2. A critical component is any component of a life support device or system whose failure to perform can be reasonably expected to cause the failure of the life support device or system, or to affect its safety or effectiveness.



National Semiconductor Corporation
 1111 West Bardin Road
 Arlington, TX 76017
 Tel: 1(800) 272-9959
 Fax: 1(800) 737-7018

National Semiconductor Europe
 Fax: (+49) 0-180-530 85 86
 Email: cnjwge@tevm2.nsc.com
 Deutsch Tel: (+49) 0-180-530 85 85
 English Tel: (+49) 0-180-532 78 32
 Français Tel: (+49) 0-180-532 93 58
 Italiano Tel: (+49) 0-180-534 16 80

National Semiconductor Hong Kong Ltd.
 19th Floor, Straight Block,
 Ocean Centre, 5 Canton Rd.
 Tsimshatsui, Kowloon
 Hong Kong
 Tel: (852) 2737-1600
 Fax: (852) 2736-9960

National Semiconductor Japan Ltd.
 Tel: 81-043-299-2309
 Fax: 81-043-299-2408

National does not assume any responsibility for use of any circuitry described, no circuit patent licenses are implied and National reserves the right at any time without notice to change said circuitry and specifications.