



TRUE
POSTURE

True Posture

Sponsored by Alcon-TrueVision

Dom Jiang, Jiyu Zhou, Prabal Saha
Nov 22, 2019



Project Description

Alcon TrueVision invented the innovative heads-up heads-up, three-dimensional imaging technology to assist in microsurgeries. Traditionally, surgeons have to do microsurgeries in a hunched posture because they need to look closely into the microscope.

The goal of this project is to quantify the muscle fatigue level difference between the two postures of hunch and heads-up by capturing EMG signals from back and neck muscles.

Traditional Microsurgery



NgeNuity 3D Visualization System for Digitally Assisted Vitreoretinal surgery from Alcon TrueVision

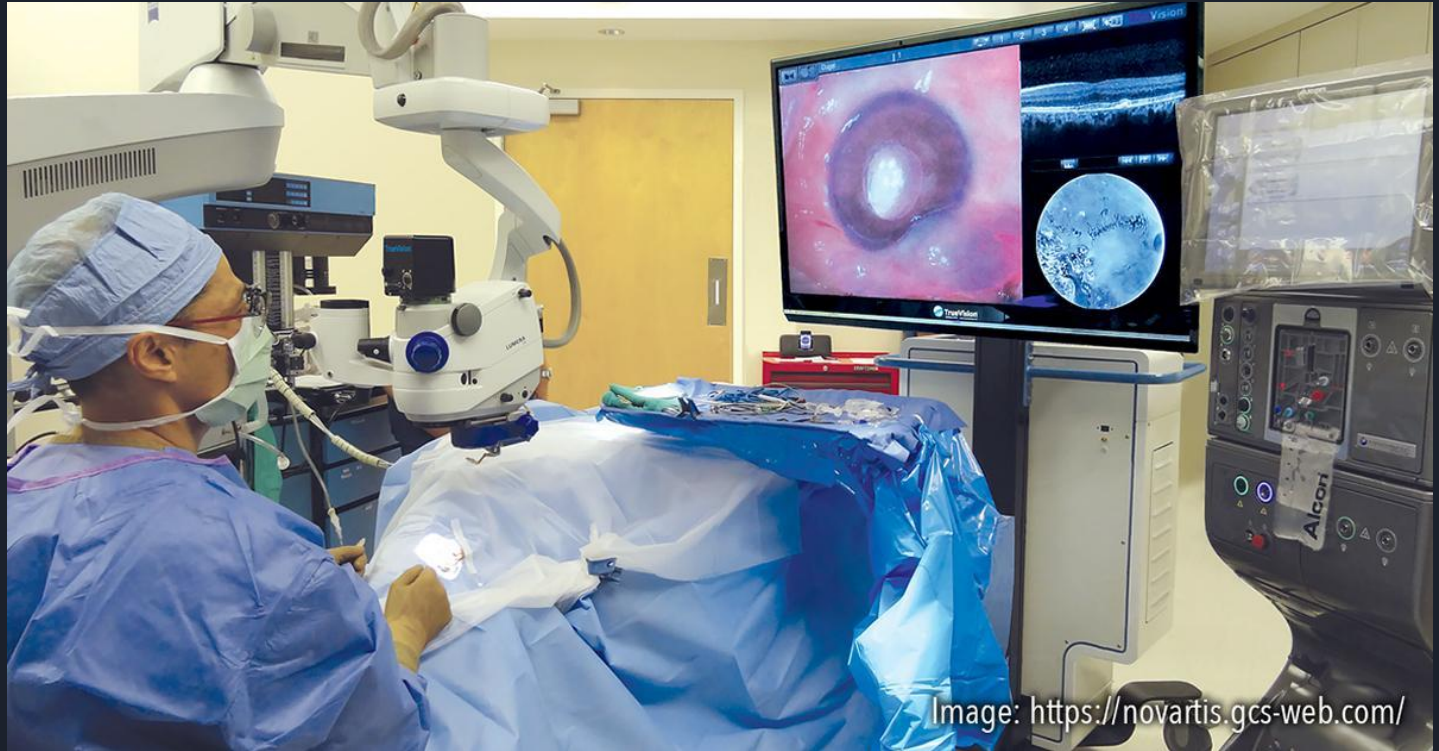



EMG Signal Origin

Semi-permeable Membrane

An ionic difference between the inner and outer spaces of a muscle cell forms a **resting potential** at the fiber membrane (approximately -80 to -90 mV).

This difference in potential, maintained by ion pump, results in a negative intracellular charge compared to the external surface.

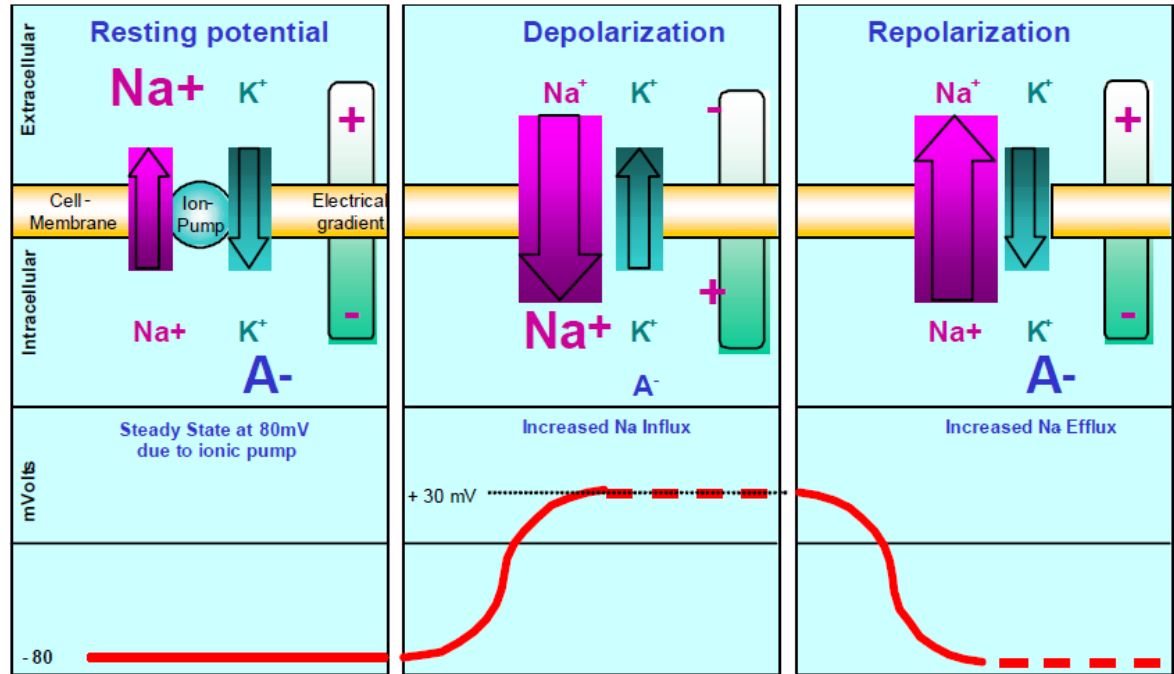

Depolarization and repolarization cycle within excitable membranes

Signal Propagation

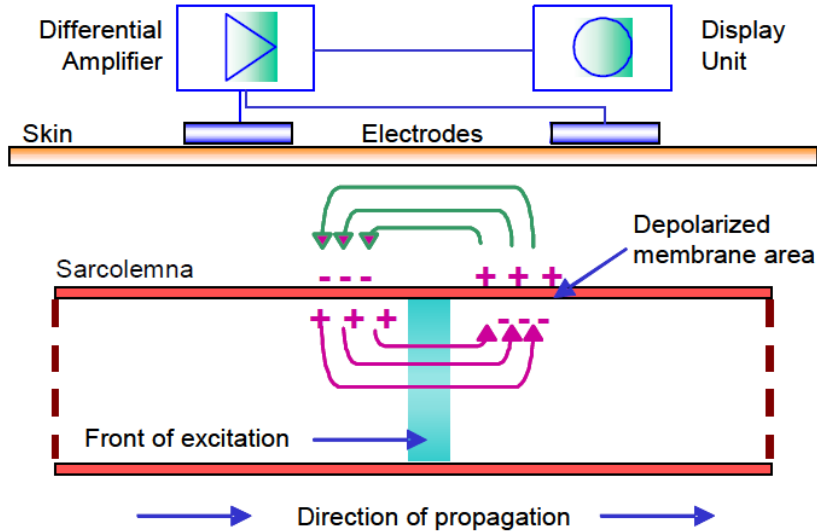
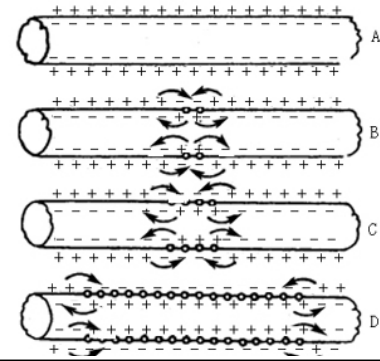

Left. Depolarization zone on muscle fiber membrane

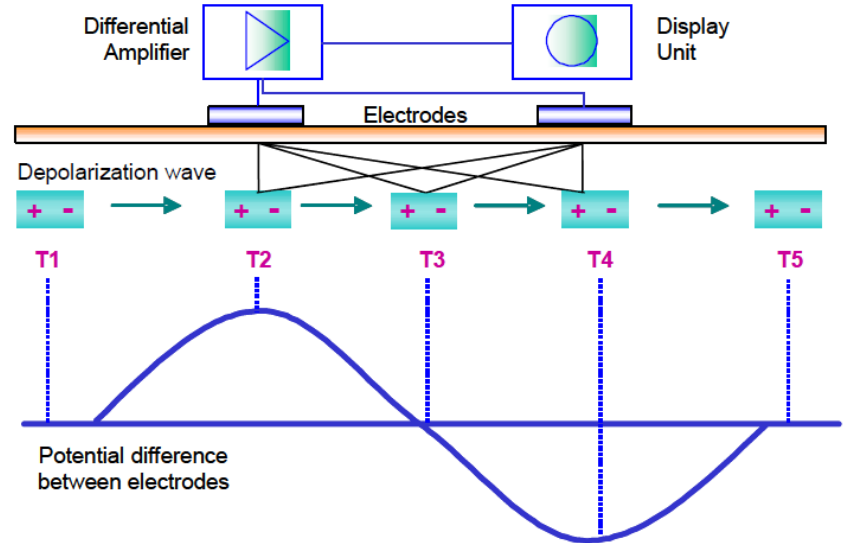

Right. Wandering electrical depole on

Raw EMG Signal Sample

An unfiltered and unprocessed signal detecting the superposed motor unit action potentials is called a raw EMG signal.

Raw sEMG can range between +/- 5000 mV and typically the frequency contents ranges between 6 and 500 Hz, showing most frequency power between ~ 20 and 150 Hz.

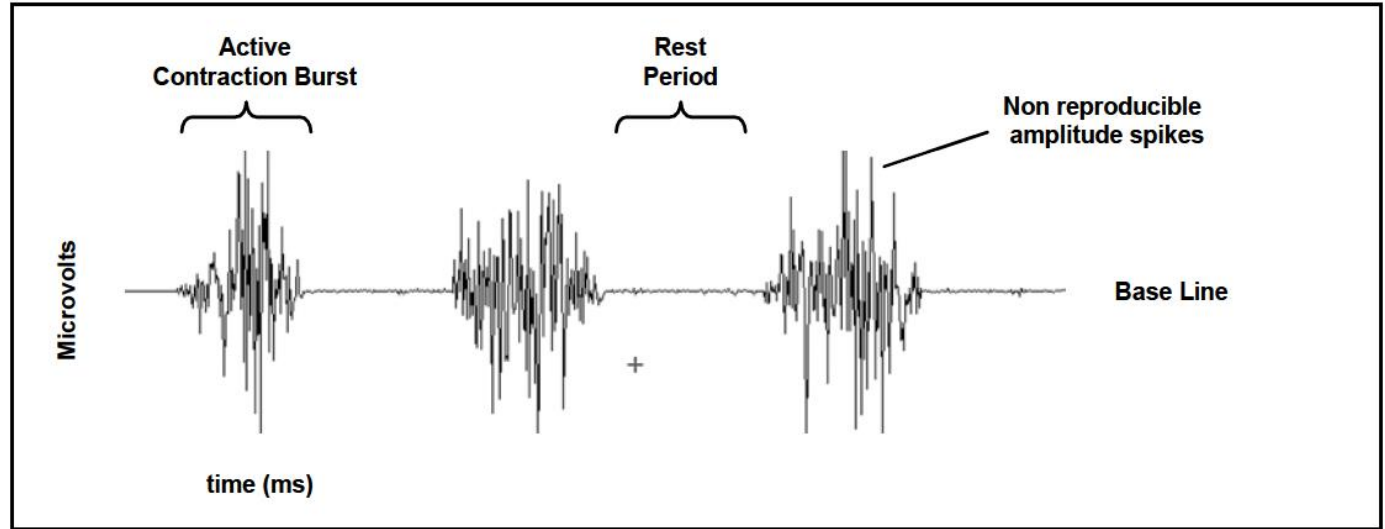

The Raw EMG recording of 3 contractions bursts.

Muscle Fatigue

Due to recruitment of motor units, the amplitude shows an increase, whereas the frequency based mean or median frequency of the total power spectrum show a decrease over contraction time.

The latter ones decline because, besides other reasons, the conduction velocity of the motor actions potentials on the muscle membrane decreases.

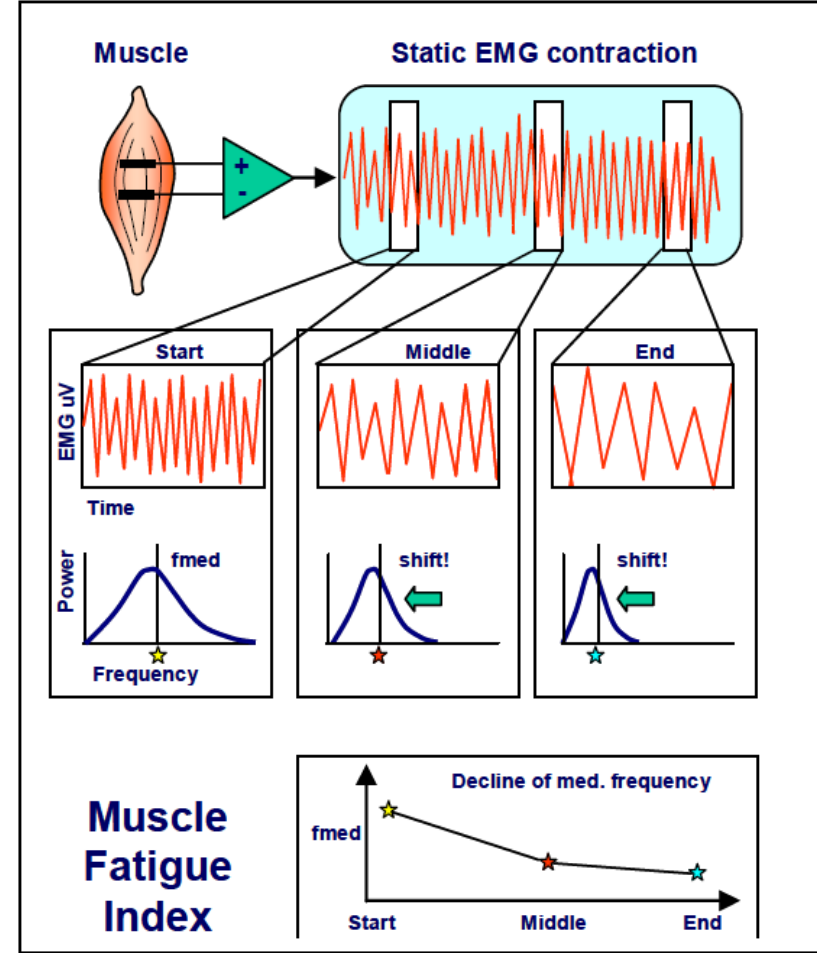
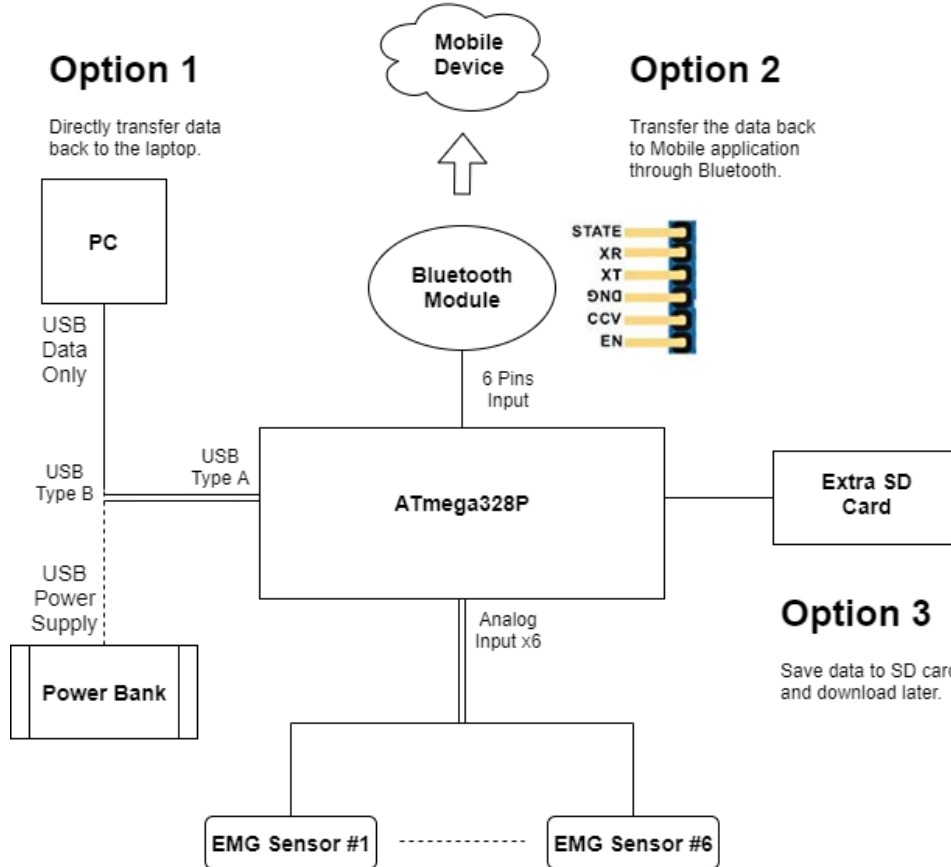

Fig. 77: Schematic illustration of the frequency shift towards lower frequencies in sustained contractions and calculation of the muscle fatigue index. Adopted and redrawn from De Luca

Circuit Block Diagram



Circuit takes USB power bank as the power supply.

Three options to collect EMG signals.

Sample Signal (Raw)

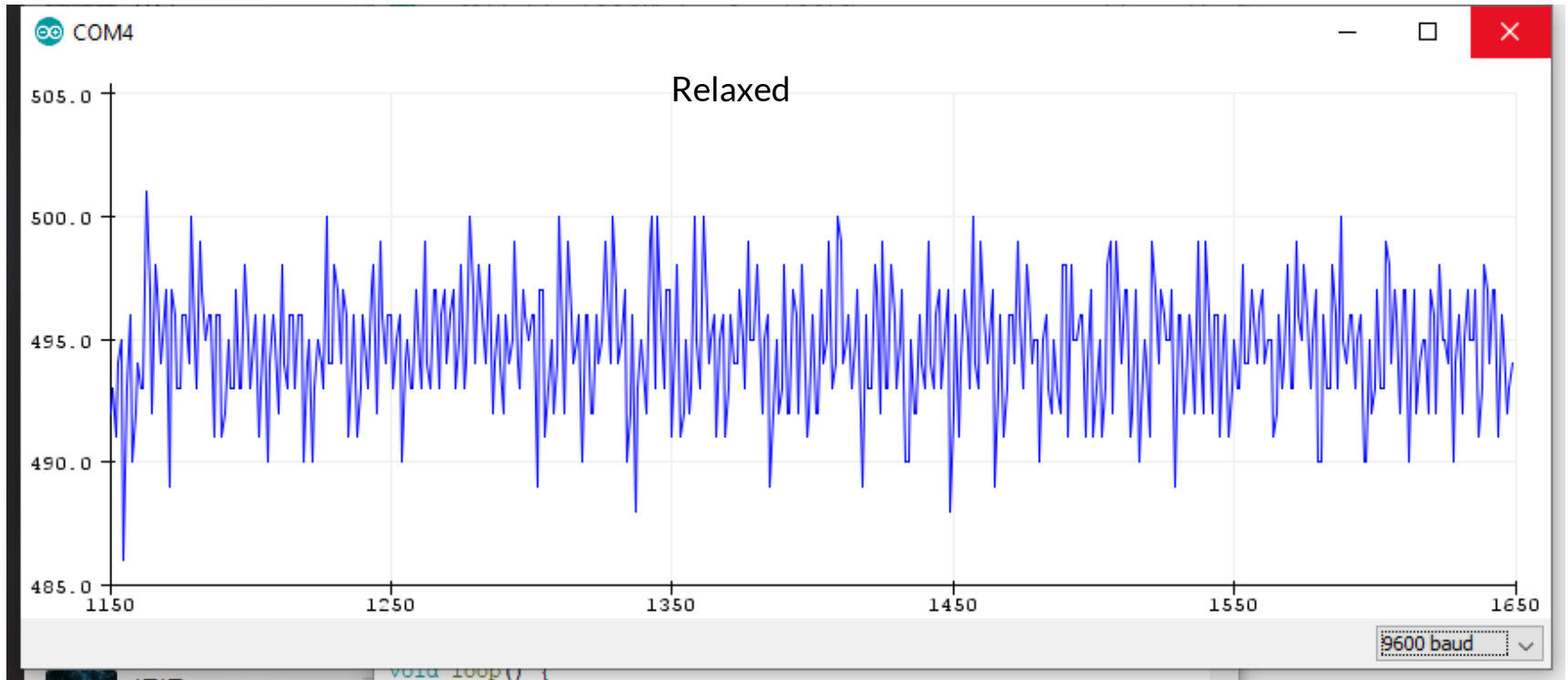

Sample Signal (Raw)

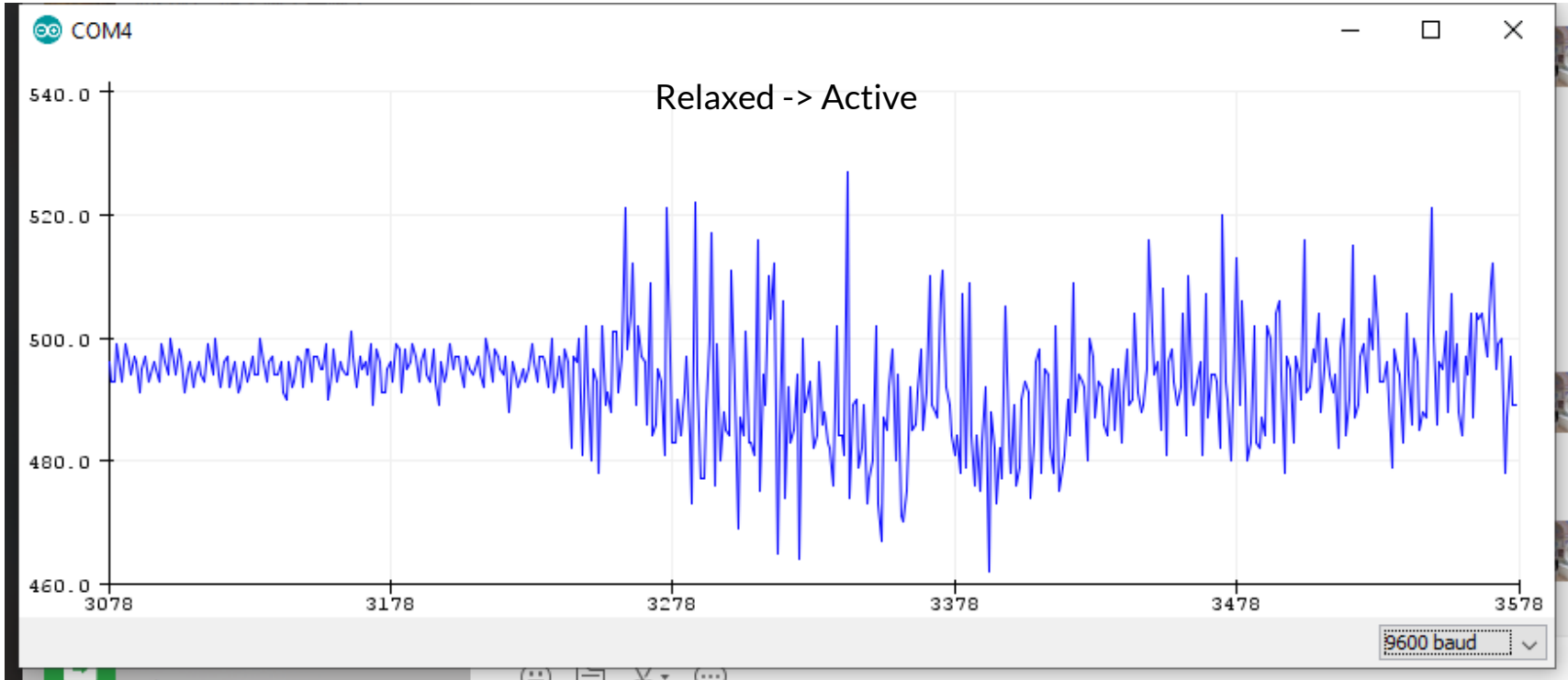

Sample Signal (Raw)

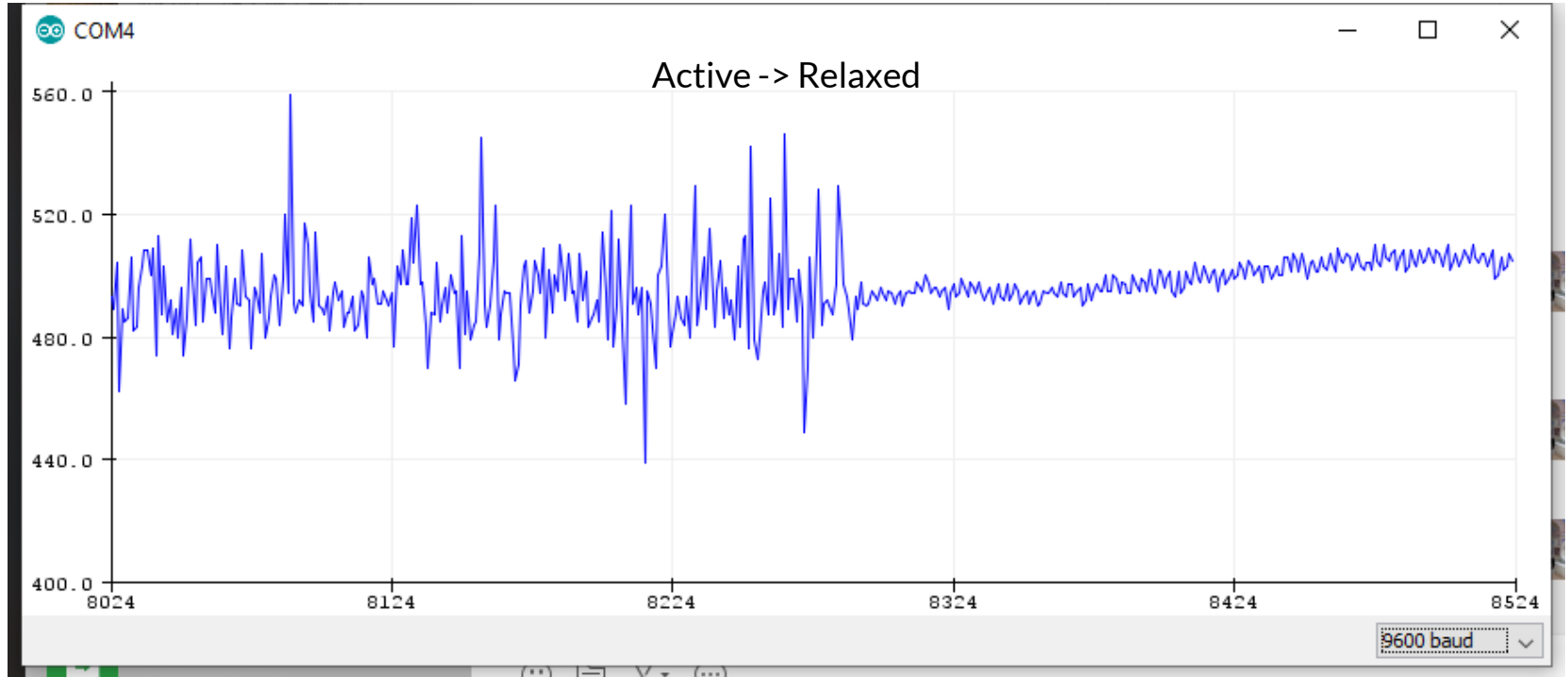

Sample Signal (Rectified & Integrated)

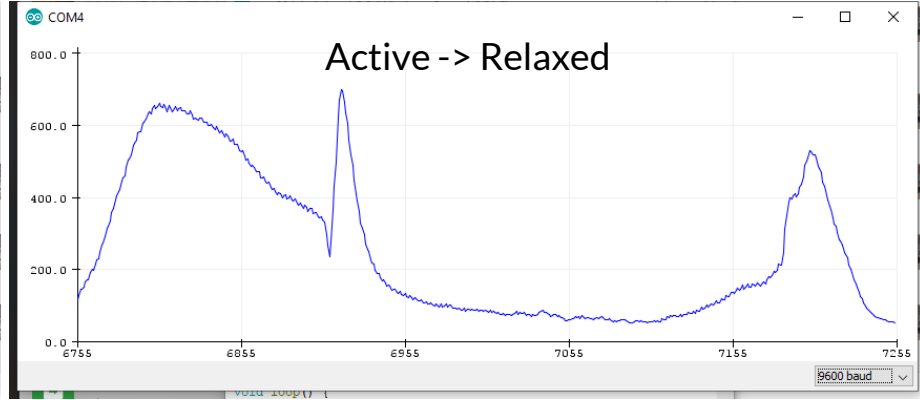
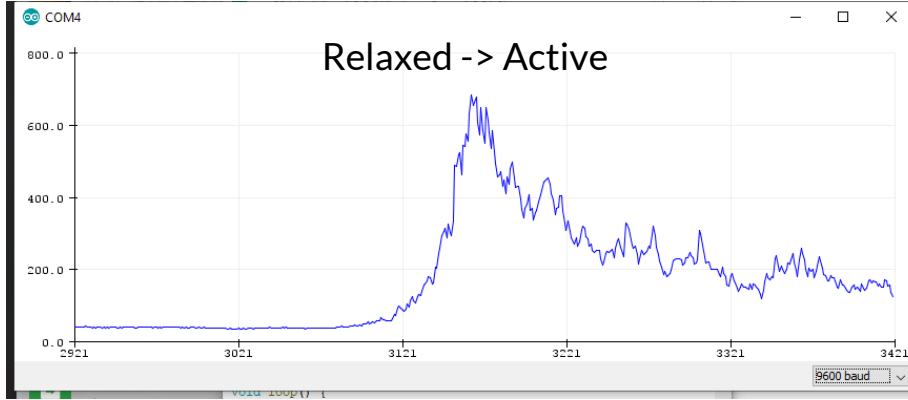



Experiment Objective

Measure the EMG signals for both postures before, during, and after surgery, since muscle fatigue causes EMG signal to increase the amplitude and decrease the frequency. Compare the changes in EMG signals in two postures and make a conclusion.

Trapezius Sensor Placement

Trapezius Ascendens (lower)



Transversalis (middle)

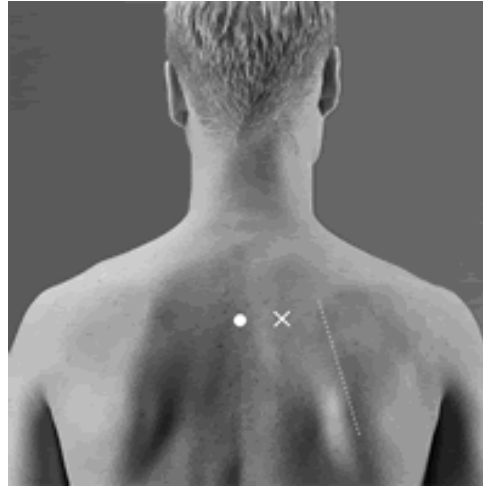

Trapezius Descendens (upper)

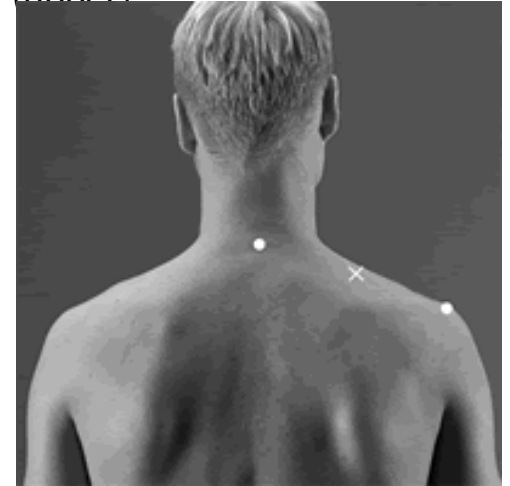

Trunk & (lower) Back Sensor Placement

Iliocostalis

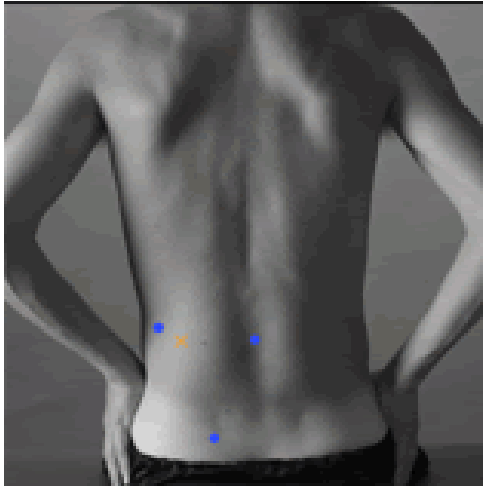

Multifidus



longissimus

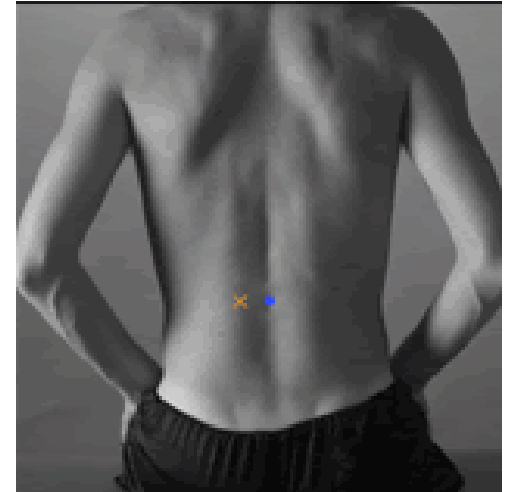



EMG Processing and Classification

(Machine Learning)

Kalman filter

- Recursive Estimator
- Takes imprecise measurements and computes the estimate for the current state
- Kalman filter deals effectively with uncertainty from noisy sensor data
- Uses a weighted average, as values with better (smaller) estimated uncertainty are “trusted” more

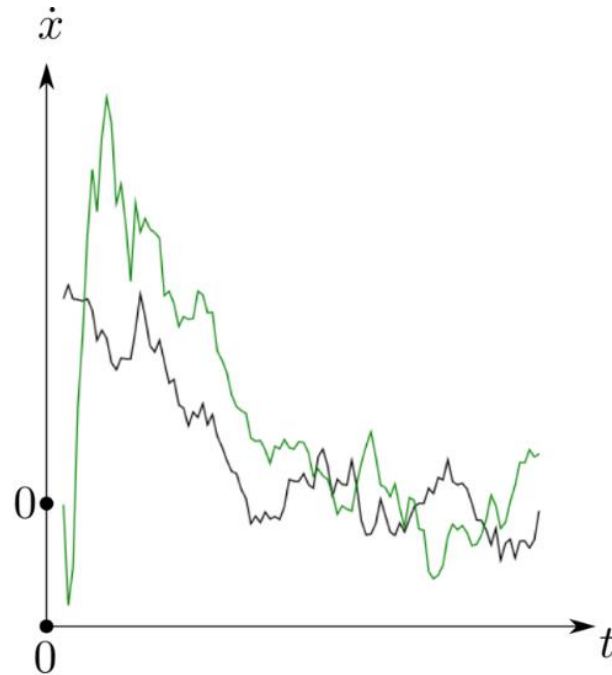
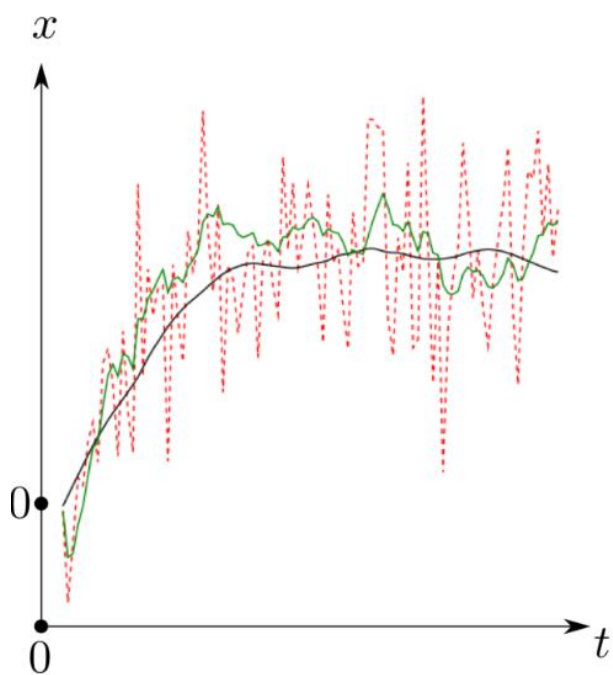

■ Truth; ■ filtered process; ■ observations.



Naive Bayes

- Simplest classifier used in Machine Learning
- Based on Bayes' theorem with strong (naive) independence assumptions between features
- The assumption might not be true, hence the name *Naive* Bayes classifier
- Adapts quickly to changes in a smaller training set



Random Forest

- Learning method for classification and regression
- Constructs decision trees during training and outputting the class (classification) or mean prediction (regression) of the trees
- Individual trees are usually grown deep to learn irregular patterns (and overfit training set) [low bias but high variance]
- Random forests average multiple decision trees on different parts of the training set

Sample EMG classification

Different signals for the activity: walking

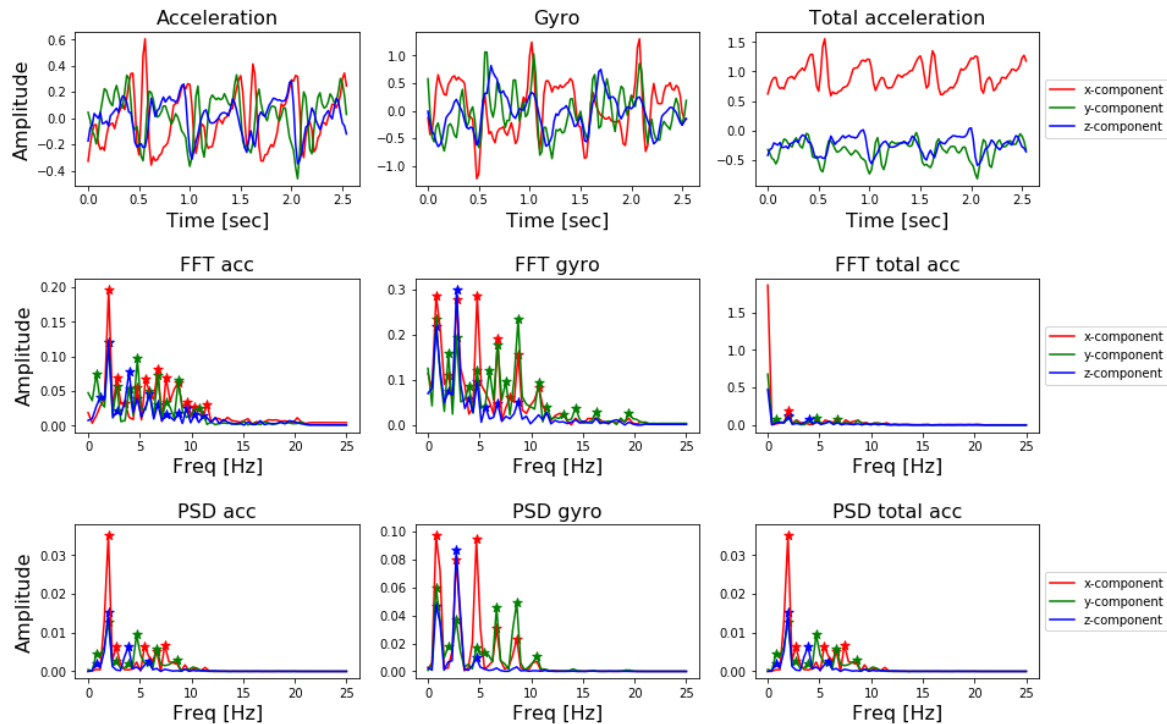



Reference

Konrad, Peter. "The abc of emg." *A practical introduction to kinesiological electromyography* 1.2005 (2005): 7-11.

"Kalman Filter." Wikipedia, Wikimedia Foundation, 20 Nov. 2019, en.wikipedia.org/wiki/Kalman_filter.

"Random forest." Wikipedia, Wikimedia Foundation, 20 Nov. 2019, en.wikipedia.org/wiki/Random_forest

Taspinar, Ahmet. "Machine Learning with Signal Processing Techniques.", 12 Apr. 2018, ataspinar.com/2018/04/04/machine-learning-with-signal-processing-techniques/.